

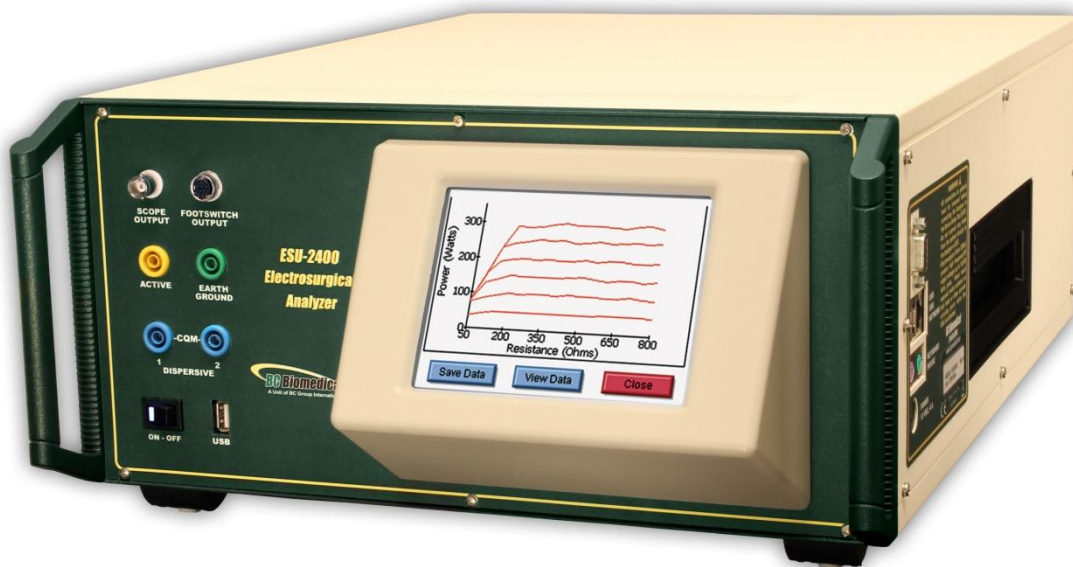

ELECTROSURGICAL UNIT ANALYZER



ESU-2400 Series

USER MANUAL

<p>BC BIOMEDICAL ESU-2400 TABLE OF CONTENTS</p>
--

WARNINGS, CAUTIONS, NOTICES	iv
DESCRIPTION.....	1
Accessories	3
OVERVIEW.....	6
TYPICAL MEASUREMENT CONNECTIONS.....	7
Monopolar	7
Bipolar.....	8
External Loads.....	9
Tissue Response Test	11
Leakage Mode 1a	12
Leakage Mode 1b	13
Leakage Mode 2	14
Leakage Mode 3	15
 GETTING STARTED	
Measure RF Energy	
Scenario 1: Measure mA, 500 ohm load, manual DUT trigger	17
Scenario 2: Measure mA and Watts, 300 ohm load, footswitch triggers DUT	19
Scenario 3: Measure Hyfrecator mA, 200 ohm load, manual DUT trigger	22
 Measure RF Leakage	
Leakage Test 1a: Active to Ground.....	24
Leakage Test 1b: Dispersive to Ground.....	26
Leakage Test 2: Ground Referenced DUT, Active to Ground	28
Leakage Test 3: Ground Referenced DUT, Dispersive to Ground	30
 REM/ARM/CQM Test	
Scenario 1: Test REM at 35 ohms	32
Scenario 2: Increase REM by 40%	33
 Load Curves	
Scenario 1: Bipolar, 60W, 100 to 1000 ohms, auto trigger DUT.....	34
Scenario 2: Pure Cut, 300W, Load List, manual trigger DUT	37

Autosequence	
RF Measure: 200 ohms, 315mA Limit, ± 10 mA.....	40
Load Curve: Pure Cut, 300W, 50-5000 ohms, Manual Trigger	43
Auto CQM	45
MAIN SCREEN	47
AUTOSEQUENCES.....	50
Running the Autosequence	67
Autosequence Results.....	71
MEASURE RF ENERGY.....	72
Tissue Response Test.....	73
Measurement Description.....	74
Graph Screen	75
Footswitch Configuration	78
POWER LOAD CURVES	80
REM/ARM/CQM.....	87
MEASURE RF LEAKAGE	88
SYSTEM TOOLS	95
Transfer Files.....	95
Time and Date Setup.....	96
Touchscreen Calibration.....	97
System Setup	98
System Version and Updates	99
Networking.....	104
Remote Mode	105
Internet Access.....	107
RS-232 Terminal	107
COMMON DIALOG SCREENS.....	109
File Open.....	109
File Save	110
Keypad	111
Numpad.....	112
Print.....	113
KEYBOARD / MOUSE	116

BARCODE SCANNER	116
ERROR MESSAGES	117
INPUTS AND OUTPUTS	120
DFA® TECHNOLOGY	122
FOOTSWITCH CONNECTOR	123
COMMUNICATION PROTOCOL	124
COMMUNICATION COMMAND SUMMARY	131
FREQUENTLY ASKED QUESTIONS (FAQ)	135
MANUAL REVISIONS.....	137
LIMITED WARRANTY.....	137
SPECIFICATIONS	139
NOTES.....	144

WARNING - USERS

The ESU-2400 is for use by skilled technical personnel only.

WARNING - USE

The ESU-2400 is intended for testing only and should never be used in diagnostics, treatment or any other capacity where it would come in contact with a patient.

WARNING - USE

Never touch exposed metal surfaces on test leads or other current-carrying parts while the DUT is activated.

WARNING - MODIFICATIONS

The ESU-2400 is intended for use within the published specifications. Any application beyond these specifications or any unauthorized user modifications may result in hazards or improper operation.

WARNING - CONNECTIONS

All connections to patients must be removed before connecting the DUT to the ESU-2400. A serious hazard may occur if the patient is connected when testing with the ESU-2400. Do not connect any leads from the patient directly to the ESU-2400 or DUT.

WARNING - POWER ADAPTOR

Unplug the Power Adaptor before cleaning the surface of the ESU-2400.

WARNING - LIQUIDS

Do not submerge or spill liquids on the ESU-2400. Do not operate the ESU-2400 if internal components not intended for use with fluids may have been exposed to fluid, as the internal leakage may have caused corrosion and be a potential hazard.

CAUTION - SERVICE

The ESU-2400 is intended to be serviced only by authorized service personnel. Troubleshooting and service procedures should only be performed by qualified technical personnel.

CAUTION - ENVIRONMENT

Exposure to environmental conditions outside the specifications can adversely affect the performance of the ESU-2400. Allow ESU-2400 to acclimate to specified conditions for at least 30 minutes before attempting to operate it.

CAUTION - CLEANING

Do not immerse. The ESU-2400 should be cleaned by wiping gently with a damp, lint-free cloth. A mild detergent can be used if desired.

CAUTION - INSPECTION

The ESU-2400 should be inspected before each use for wear and the ESU-2400 should be serviced if any parts are in question.

CAUTION - VENTILATION

The ESU-2400 includes ventilation slots to help prevent overheating during operation and should not be blocked.



NOTICE – CE



The ESU-2400 Analyzers bear the  mark
Based on the following testing standards:

ELECTROMAGNETIC COMPATIBILITY DIRECTIVE

EN 61326-1:2005 (EN61326-1:2006)
“Electrical equipment for measurement, control and
laboratory use – EMC requirements”

This equipment has been type tested by an independent, accredited testing laboratory
and compliance was demonstrated to the above standard to the extent applicable.

EMISSIONS

Radiated and Line Conducted Emissions

EN 61000-3-2
EN 61000-3-3

Harmonic Current Emissions
Voltage Fluctuation and Flicker

IMMUNITY– CLASS C

EN 61000-4-2
EN 61000-4-3
EN 61000-4-4
EN 61000-4-5
EN 61000-4-6
EN 61000-4-11

Electrostatic Discharge
Radiated Electric Field Immunity
Electrical Fast Transients / Bursts
Surge Voltage
Conducted Disturbance
Voltage Dips and Short Interrupts

LOW VOLTAGE DIRECTIVE **EC – Directive 73/23/EC**

EN 61010-1:2001
“Safety requirements for electrical equipment for measurement, control, and
laboratory use – General requirements”

This equipment has been type tested and compliance was demonstrated
to the above standard to the extent applicable.

NOTICE – SYMBOLS

Symbol

Description



Caution
(Consult Manual for Further Information)



Per European Council Directive
2002/95/EC, do not dispose of this
product as unsorted municipal waste.

NOTICE – ABBREVIATIONS

AAMI	Association for the Advancement of Medical Instrumentation
Amps	Amperes
ANSI	American National Standards Institute
ARM™	Aspen Return Monitor
C	Celsius
CF	Crest Factor
CQM	Contact Quality Monitor
°	degree
DFA	Digital Fast Acquisition
DUT	Device Under Test
hrs	hours
Hz	hertz
IEC	International Electrotechnical Commission
kg	Kilogram(s)
kHz	kilohertz
lbs	pounds
MHz	Megahertz
mA	milliampere(s)
mm	millimeter(s)
ms	millisecond(s)
mV	millivolt(s)
Ω	ohm(s)
PC	Personal Computer
Pk	peak
REM	Return Electrode Monitor
RF	Radio Frequency
RMS	Root Mean Square
USA	United States of America
V	Volt(s)

NOTICE – PERFORMING TESTS

REFER TO DUT MANUFACTURER'S SERVICE MANUAL FOR
TEST PROCEDURES AND MEASUREMENT LIMITS.

NOTICE – DISCLAIMER

USER ASSUMES FULL RESPONSIBILITY FOR UNAUTHORIZED
EQUIPMENT MODIFICATIONS OR APPLICATION OF EQUIPMENT
OUTSIDE OF THE PUBLISHED INTENDED USE AND
SPECIFICATIONS. SUCH MODIFICATIONS OR APPLICATIONS
MAY RESULT IN EQUIPMENT DAMAGE OR PERSONAL INJURY.

NOTICE – DISCLAIMER

BC GROUP INTERNATIONAL, INC. RESERVES THE RIGHT TO
MAKE CHANGES TO ITS PRODUCTS OR SPECIFICATIONS AT
ANY TIME, WITHOUT NOTICE, IN ORDER TO IMPROVE THE
DESIGN OR PERFORMANCE AND TO SUPPLY THE BEST
POSSIBLE PRODUCT. THE INFORMATION IN THIS MANUAL
HAS BEEN CAREFULLY CHECKED AND IS BELIEVED TO BE
ACCURATE. HOWEVER, NO RESPONSIBILITY
IS ASSUMED FOR INACCURACIES.

NOTICE – CONTACT INFORMATION

BC BIOMEDICAL
BC GROUP INTERNATIONAL, INC.
3081 ELM POINT INDUSTRIAL DRIVE
ST. CHARLES, MO 63301
USA

1-800-242-8428
1-314-638-3800

www.bcgrouptl.com
sales@bcgrouptl.com

This Page Intentionally Left Blank

**BC BIOMEDICAL
ESU-2400
ELECTROSURGICAL UNIT ANALYZER**

The Model ESU-2400 Electrosurgical Unit Analyzer is a high-accuracy True RMS RF Measurement system designed to be used in the calibration and routine performance verification of Electrosurgical Generators. It offers a higher degree of accuracy than previously attainable with conventional Electrosurgical Unit Analyzer designs. The ESU-2400 provides an advanced low reactance internal load bank with a range of 0 to 6400 ohms in 1 ohm increments. It is microprocessor based and utilizes a combination of unique hardware and software to provide accurate and reliable test results, even from “noisy” Electrosurgical Generator waveforms such as “Spray”. The Patent Pending DFA[®] Technology utilized in the ESU-2400 allows the system to aggressively digitize the complex RF waveforms produced by Electrosurgical Generators, analyze each individual digital data point, and provide highly accurate measurement results.

The ESU-2400, unlike many conventional ESU Analyzers, has internal high voltage setup relays to control the measurement path, allowing the user to switch between Power measurements, Leakage measurements, REM/ARM/CQM testing, or even run an autosequence that could include any or all of these tests – without even moving wires around!

The current transformer internal to the ESU-2400 senses the RF current flowing through the internal test load and produces a ratiometric voltage which is digitized and analyzed by the microprocessor. Combining the standard and low ranges of the ESU-2400 with the use of the current transformer, the user has full control over the ability to get high accuracy and high resolution readings from all types of Electrosurgical Generators.

The following are highlights of some of the main features:

- TRUE RMS READINGS USING DFA® TECHNOLOGY
- INDUSTRY STANDARD CURRENT SENSING TECHNOLOGY
- mV, mV PEAK, mA, CREST FACTOR AND POWER (WATTS) RANGES
- COLOR QVGA DISPLAY WITH TOUCHSCREEN
- 1% OF READING MEASUREMENT ACCURACY
- DIGITAL CALIBRATION – NO POTS TO TURN
- SELECTABLE DISPLAY OPTIONS
- GRAPHICAL ON-SCREEN REPRESENTATION OF MEASURED RF SIGNAL
- HIGH RANGE (1000 mV) AND LOW RANGE (100 mV) WITH AUTOSCALING CAPABILITY
- PULSED RF WAVEFORM MEASUREMENT MODE FOR LOW DUTY CYCLE PULSED OUTPUTS OFFERED BY SOME ELECTROSURGICAL MANUFACTURERS
- PROGRAMMABLE AUTOSEQUENCES
- PROGRAMMABLE LOAD CURVES
- BUILT IN CQM TESTING WITH ONE OHM RESOLUTION
- TISSUE RESPONSE TESTING WITH GRAPHING CAPABILITY
- FOOTSWITCH OUTPUTS FOR TRIGGERING THE DUT
- ON-SCREEN DISPLAY OF MEASUREMENT CONFIGURATION
- THREE USB PORTS FOR KEYBOARD, MOUSE, PRINTER, OR FLASH DRIVE.
- ETHERNET PORT FOR INCREASED ACCESSIBILITY

STANDARD ACCESSORIES:

BC20 – 00130	Accessory Kit (Test Leads)
BC20 – 21107	Universal Power Supply
BC20 – 41341	Communications Cable (RS-232)
BC20 – 205XX	Standard Power Adapter (International Options, See Page 121 For Details)

Standard Accessory Kit, BC20-00130:

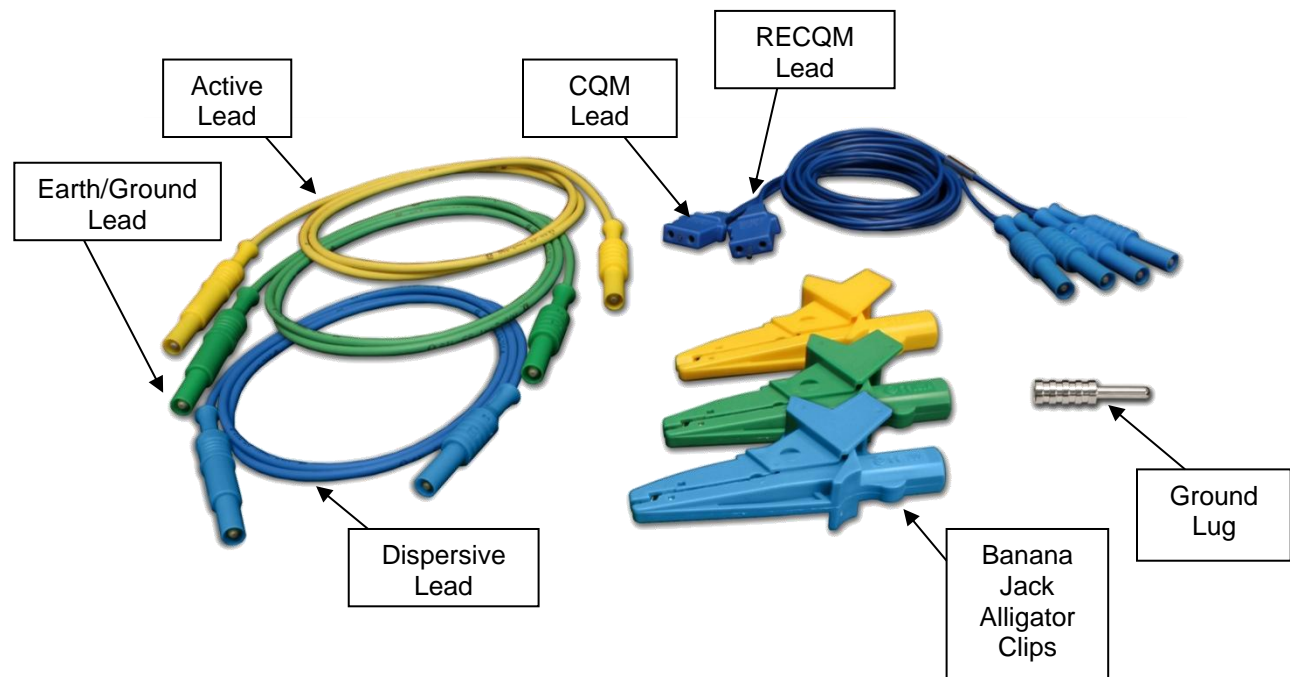

OPTIONAL ACCESSORIES:

BC20 – 00131	ForceTriad PM Accessory Kit
BC20 – 00140	Replacement packaging
BC20 – 41360	Communications Cable, USB Null Modem
BC20 – 00232	BNC To BNC Cable
BC20 – 03000	Footswitch Cable, Unterminated
BC20 – 03001	Footswitch Cable for Covidien ForceFx
BC20 – 03002	Footswitch Cable for Conmed System 5000
BC20 – 03003	Footswitch Cable for Covidien ForceTriad
BC20 – 03004	Footswitch Simulator for Covidien ForceFx and ForceTriad, triggers Cut, Coag, Bipolar
TRL – 2420	Tissue Response Load

OPTIONAL ACCESSORIES (continued):

Optional Accessory Kit, BC20-00131, ForceTriad PM Accessory Kit

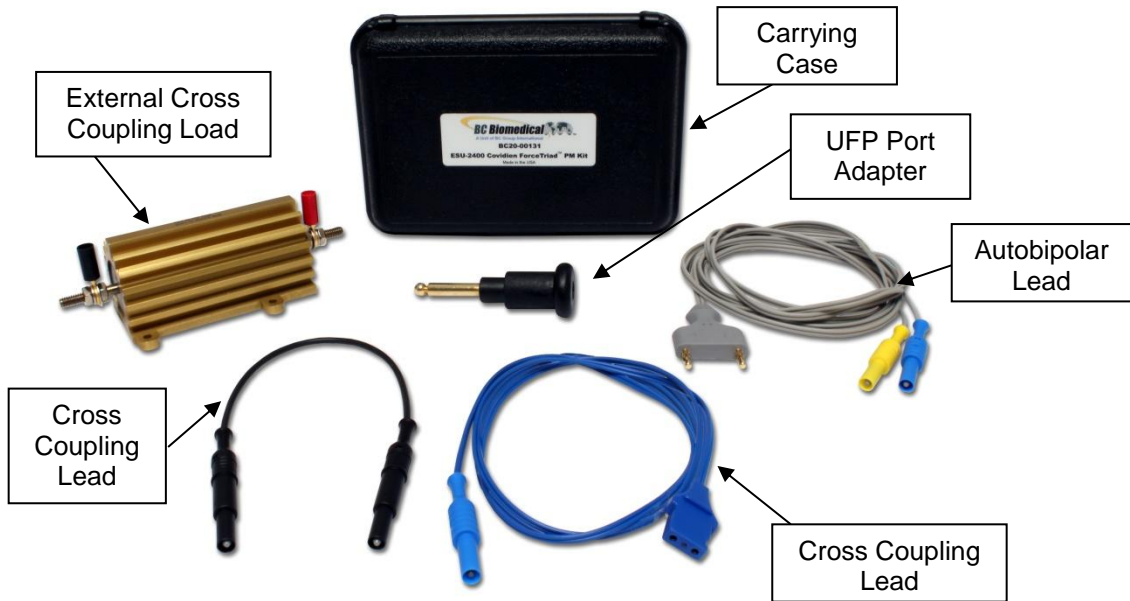

TRL-2420
Tissue Response Load



BC20-03004
Footswitch Simulator



CQM Cable Differences – Two CQM cables are provided in the standard accessory kit. The only difference between them is that one cable has a small pin and the other does not. The cable with the pin is used to enable the REM circuitry on the DUT. The cable without the pin is used to bypass the REM circuit and allow for shorting of the REM leads. Note that some generators do not allow for the REM circuit to be disabled. For these generators it does not matter which cable is used.

When using the ESU-2400 CQM test mode, the cable with the pin must be used. For other modes, the Dispersive ports on the ESU-2400 are shorted together and the cable without the pin should be used.



Cable Without Pin,
Disables REM



Cable With Pin,
Enables REM

OVERVIEW

This section looks at the layout of the ESU-2400 and gives descriptions of the elements that are present.

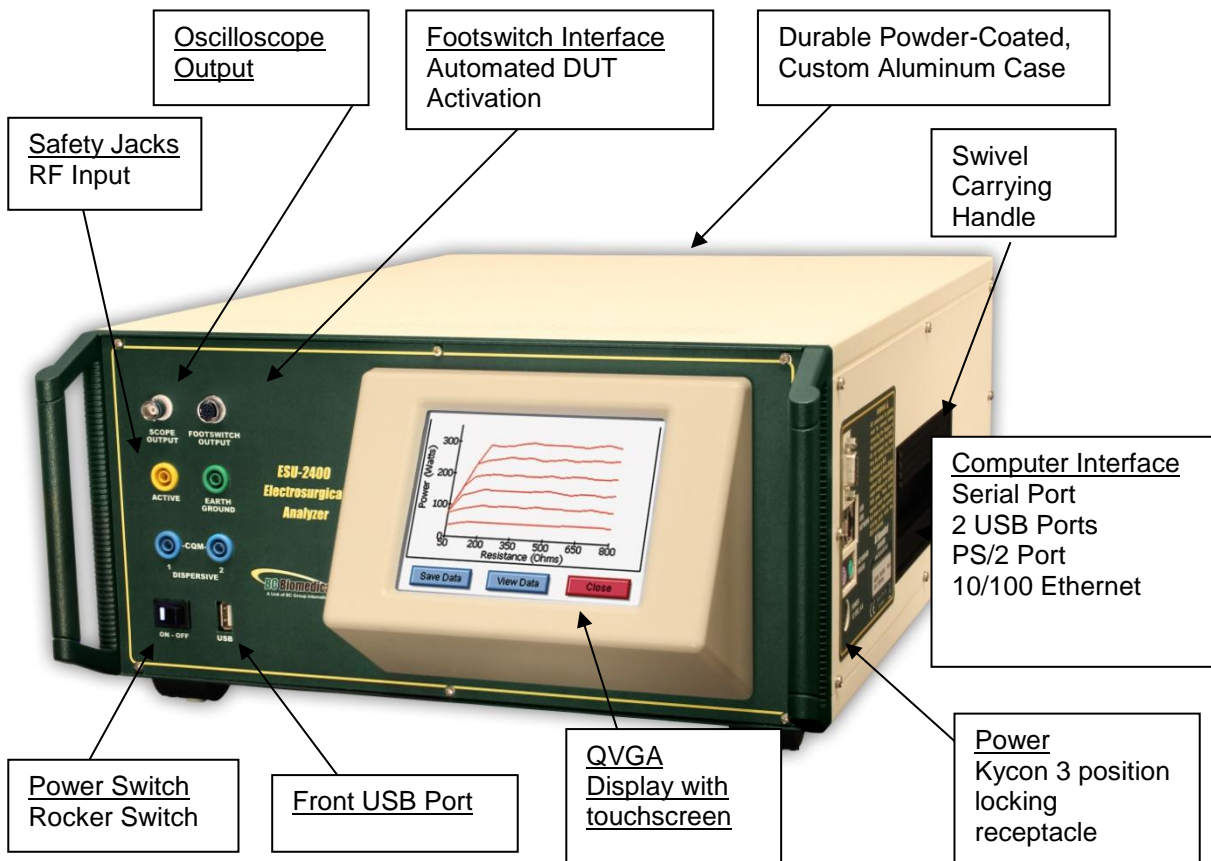

TYPICAL MEASUREMENT CONNECTIONS

The ESU-2400 Series utilizes an internal Current Transformer and internal precision load resistors for simple configuration of typical Electrosurgical Generator testing. Many of the world's leading Electrosurgical generator manufacturers utilize this exact same technique when they test, service and calibrate their generators.

Internal configuration relays allow for simple connections to the DUT. When the Measure RF Energy, Measure RF Leakage, or REM/ARM/CQM mode is selected from the main menu, the relays configure the internal connections as required. Shown below are examples of external connections to the DUT.

Monopolar:

1. Yellow Active Lead from Active Jack on ESU-2400 to DUT Output.
2. Blue Dispersive Lead from Dispersive Jack on ESU-2400 to DUT Dispersive.

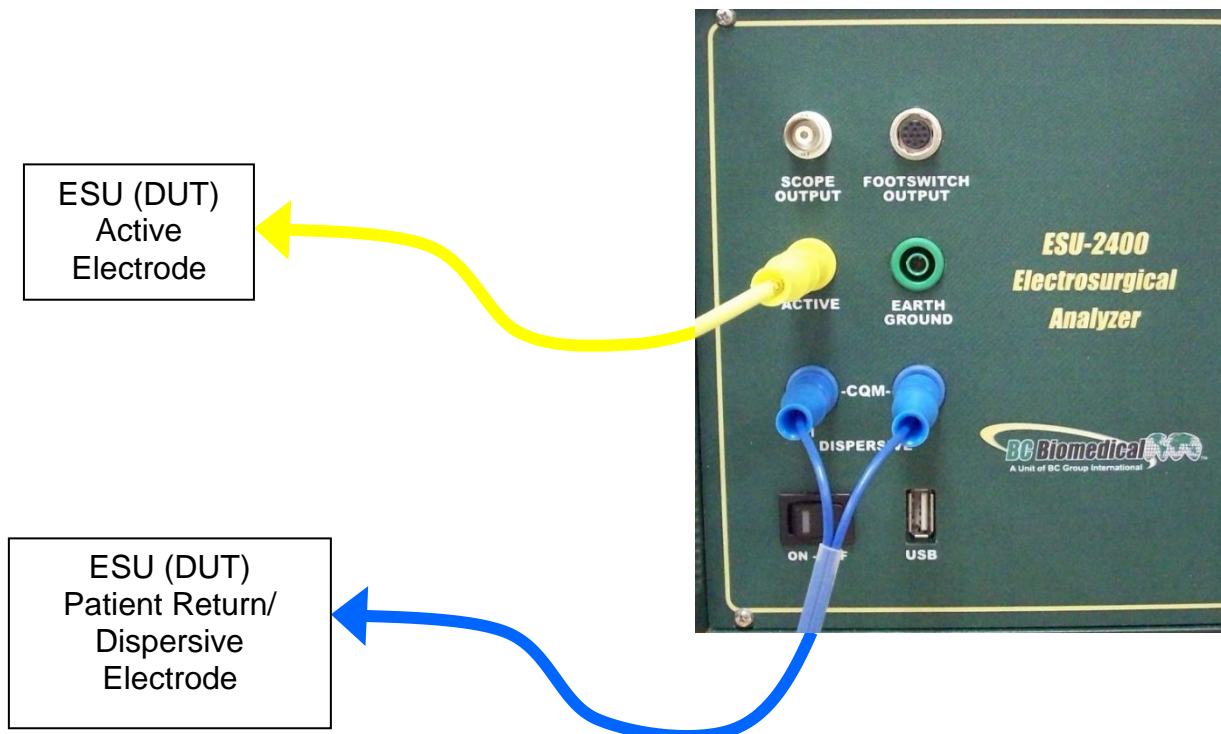

Bipolar:

1. Yellow Active Lead from Active Jack on ESU-2400 to DUT Bipolar Output Electrode #1.
2. Blue Lead from Dispersive1 Jack on ESU-2400 to DUT Bipolar Output Electrode #2.

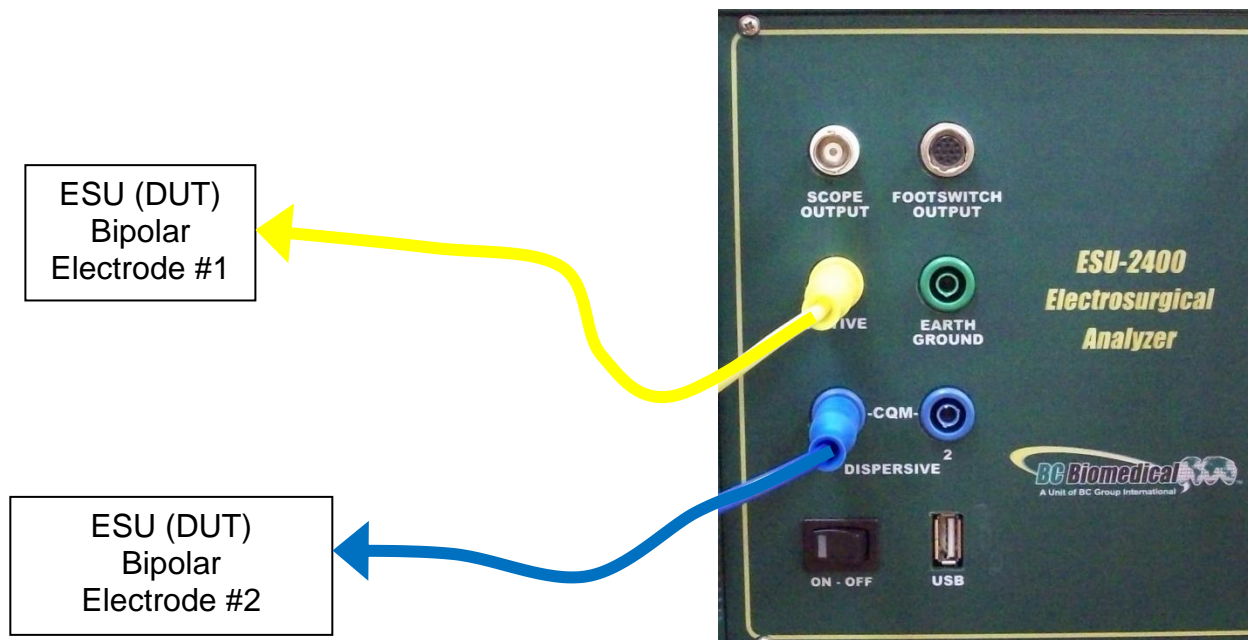

External Loads

Monopolar:

1. Yellow Active Lead from Active Jack on ESU-2400 to DUT Output.
2. Black Lead from Patient Return/Dispersive Jack on ESU-2400 to DUT Dispersive.
3. Blue Lead from Dispersive 1 Jack on ESU-2400 to External Load.
4. External Load to DUT Dispersive.

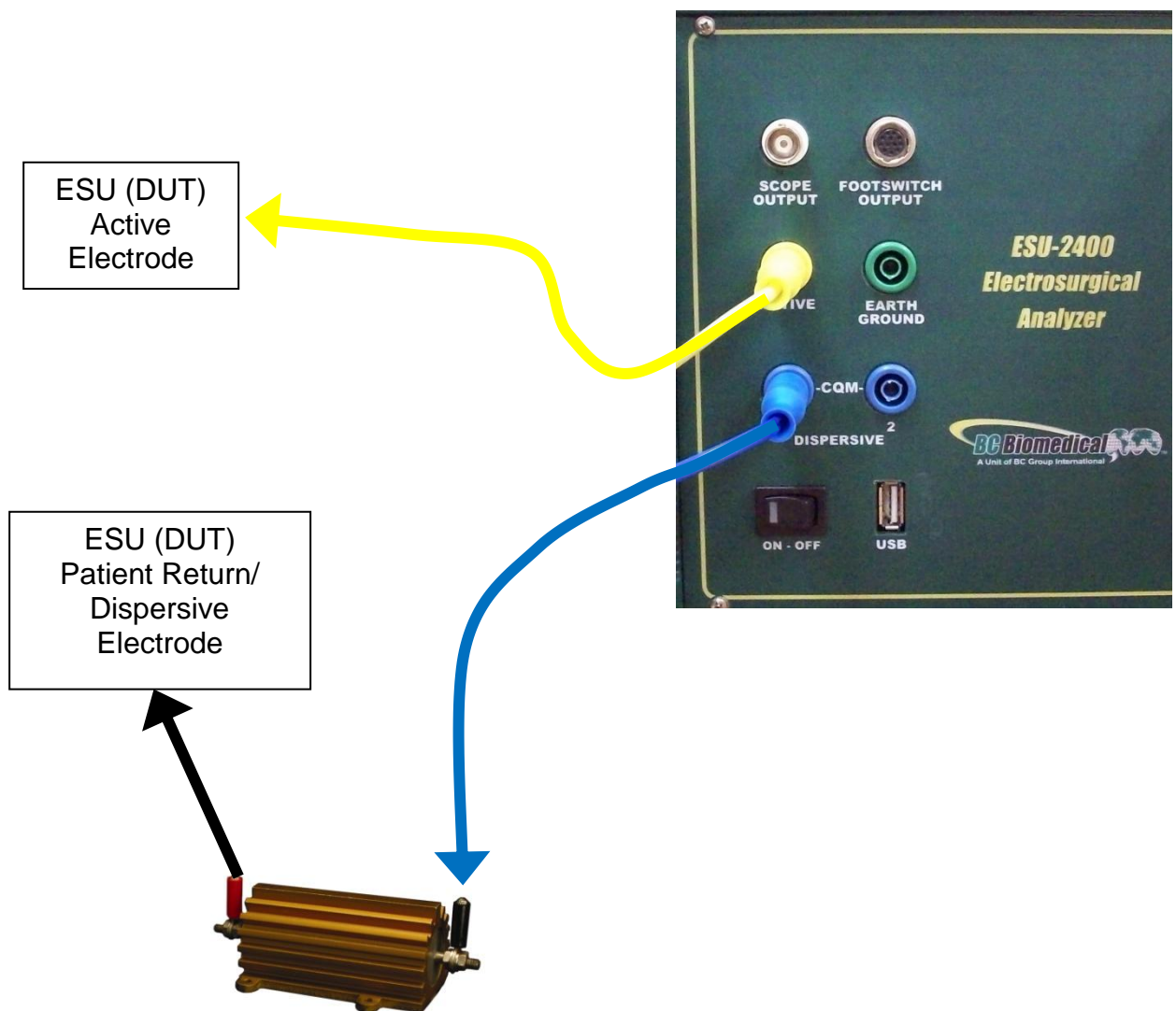

Bipolar

1. Yellow Active Lead from Active Jack on ESU-2400 to DUT Bipolar Output Electrode #1.
2. Blue Lead from Dispersive 1 Jack on ESU-2400 to External Load.
3. External Load to DUT Bipolar Output Electrode #2.

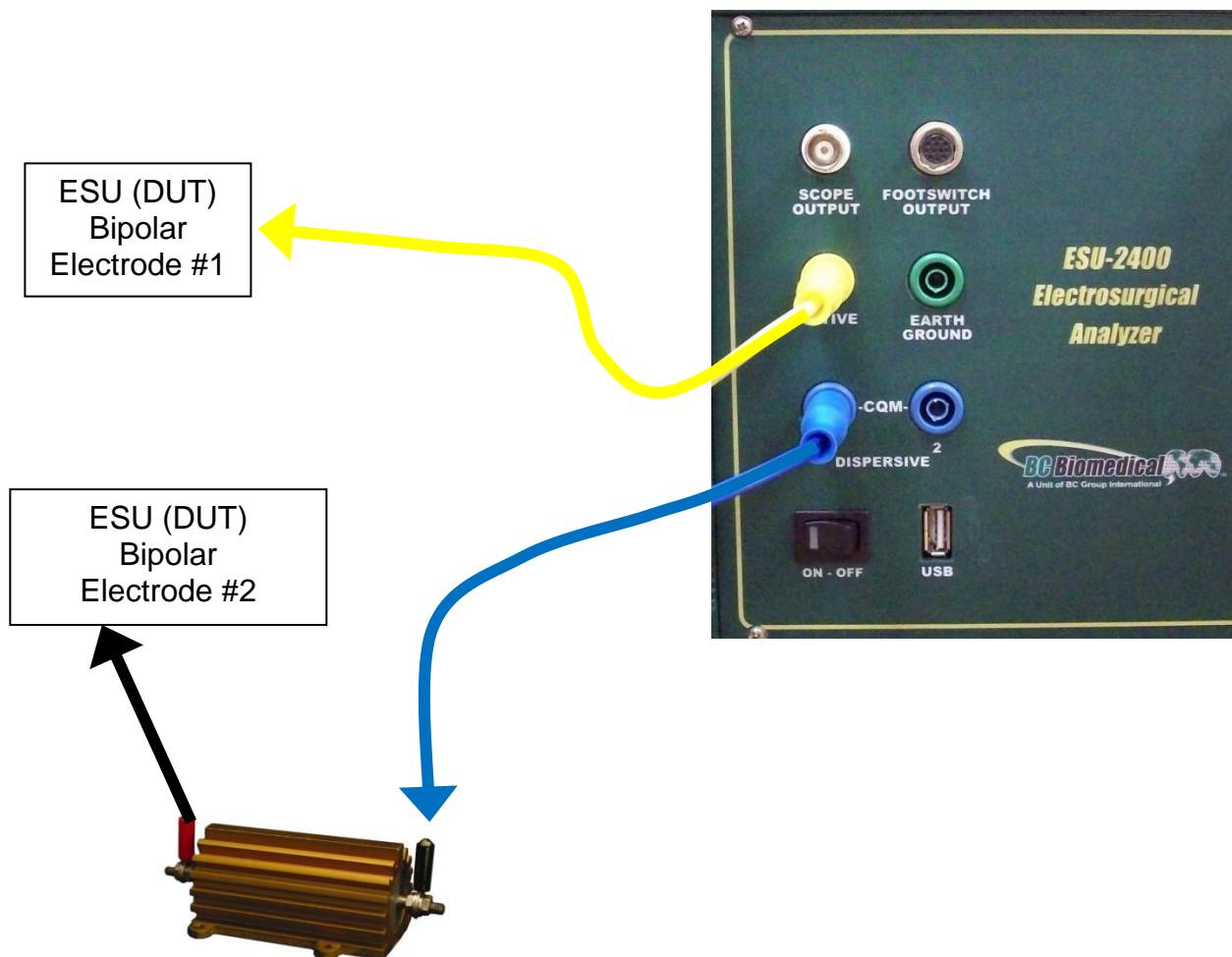

Tissue Test - This mode evaluates the tissue response function of the DUT. In this mode, the ESU-2400 is configured for an external TRL-2420 lamp load. The ESU-2400 is connected in series with the load as shown below. The terminals are labeled Return and Active for reference only. The DUT Return terminal shown below is typically not the Patient Return or REM electrode. Refer to the DUT service manual to determine which DUT ports are used for the tissue response output.

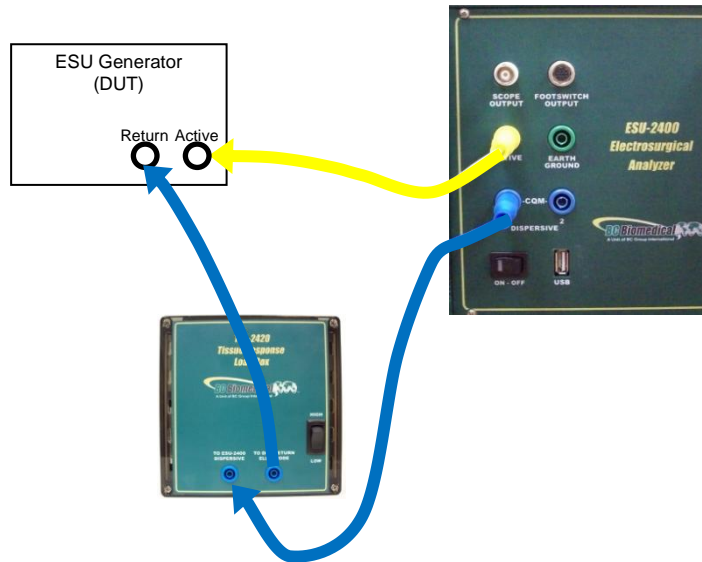

If the output terminals of the DUT are not compatible with the standard ESU-2400 safety test leads, the alligator clips supplied with the ESU-2400 accessory kit can be used to connect directly to the electrosurgical instrument as shown in the connection diagram below.

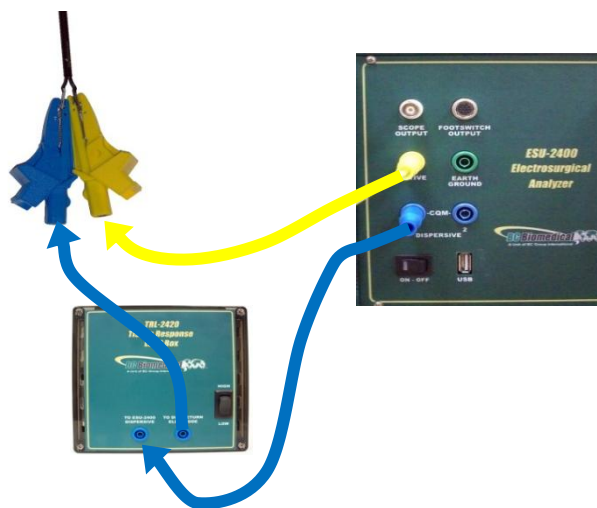

Leakage 1a This leakage test, specified by the IEC as Active Electrode to Ground, is for testing the RF leakage to earth ground of an Isolated Output type CF electrosurgical generator from a single active or dispersive lead. The test complies with IEC 601.2.2, sec. 19.101b, fig, 104 and sec. 19.102, adopted by ANSI/AAMI HF18-2001. The purpose of this test is to verify that open circuit RF leakage of the Device Under Test (DUT) meets or exceeds the IEC specification. The ESU-2400 internally connects the load to earth ground. An external ground is also provided at the front panel.

NOTE: DO NOT TEST AN EARTH REFERENCED TYPE BF ELECTROSURGICAL GENERATOR WITH THIS TEST, THE RESULTING MEASUREMENT WILL BE ERRONEOUS.

WARNING – ONE LEAD AT A TIME
Only test one lead of the ESU Generator at a time, either Active or Dispersive, not both.

Connections

1. Active Jack on ESU-2400 to DUT Active Output or Bipolar 1.

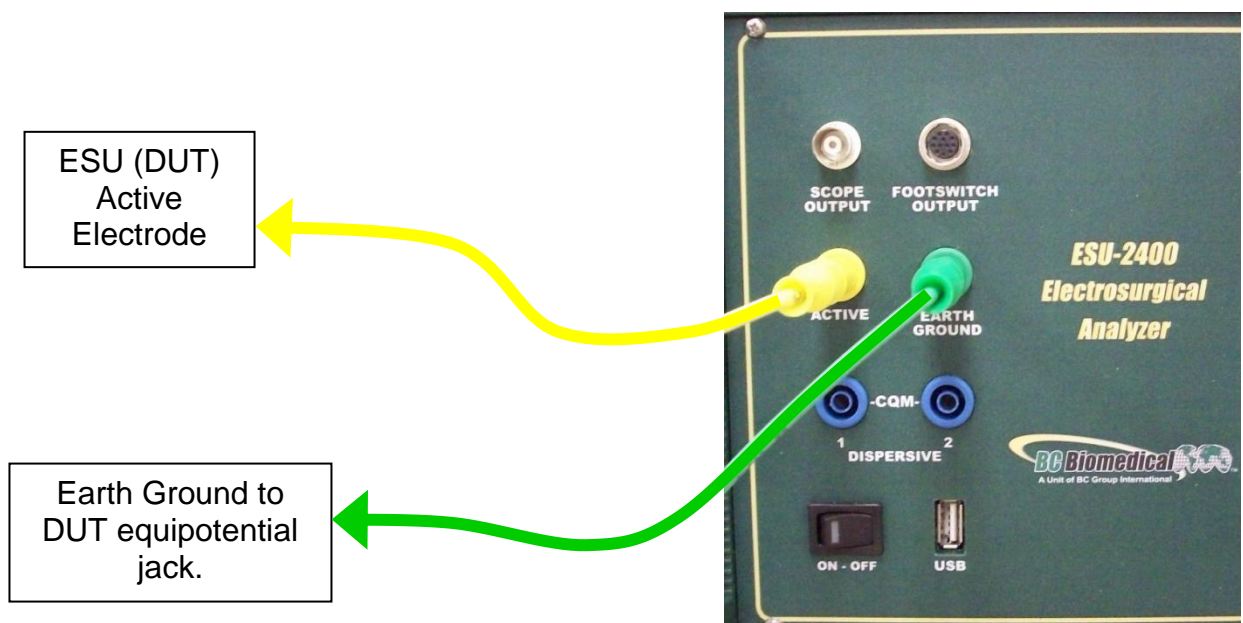

Leakage 1b This leakage test, specified by the IEC as Dispersive Electrode to Ground, is for testing the RF leakage to earth ground of an Isolated Output type CF electro-surgical generator from a single active or dispersive lead. The test complies with IEC 601.2.2, sec. 19.101b, fig, 104 and sec. 19.102, adopted by ANSI/AAMI HF18-2001. The purpose of this test is to verify that open circuit RF leakage of the Device Under Test (DUT) meets or exceeds the IEC specification. The ESU-2400 internally connects the load to earth ground. An external ground is also provided at the front panel.

NOTE: DO NOT TEST AN EARTH REFERENCED TYPE BF ELECTROSURGICAL GENERATOR WITH THIS TEST, THE RESULTING MEASUREMENT WILL BE ERRONEOUS.

WARNING – ONE LEAD AT A TIME
Only test one lead of the ESU Generator at a time, either Active or Dispersive, not both.

Connections

1. Dispersive 1 Jack on ESU-2400 to DUT Dispersive Output or Bipolar 2.

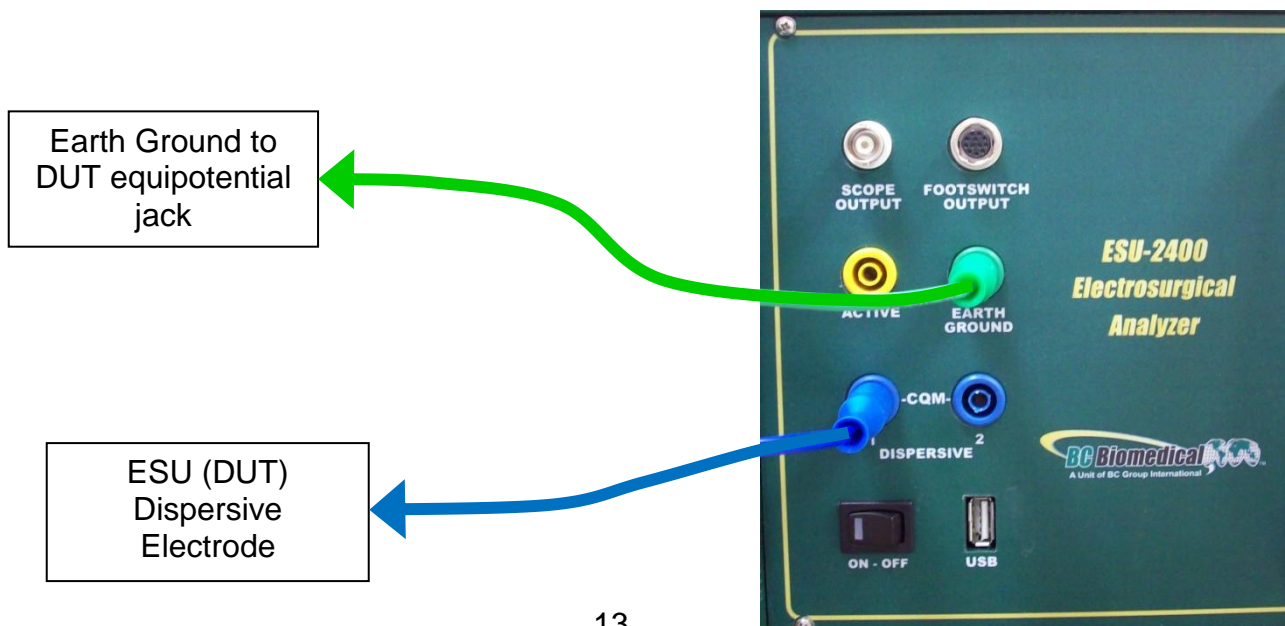

Leakage 2 This leakage test, specified by the IEC as Earth Reference Leakage Type BF (Load Between Electrodes), is for testing the leakage to earth ground of a Ground Referenced Output type BF electro-surgical generator from the active output. This test complies with IEC 601.2.2, sec. 19.101a, test 1, fig. 102, and sec. 19.102, adopted by ANSI/AAMI HF18-2001. The purpose of this test is to verify that the RF leakage of the Device Under Test (DUT) meets or exceeds the IEC specification.

Connections

1. Active Lead from Active Jack on ESU-2400 to DUT Active Output.
2. Dispersive Lead from Dispersive Jack on ESU-2400 to DUT Dispersive.

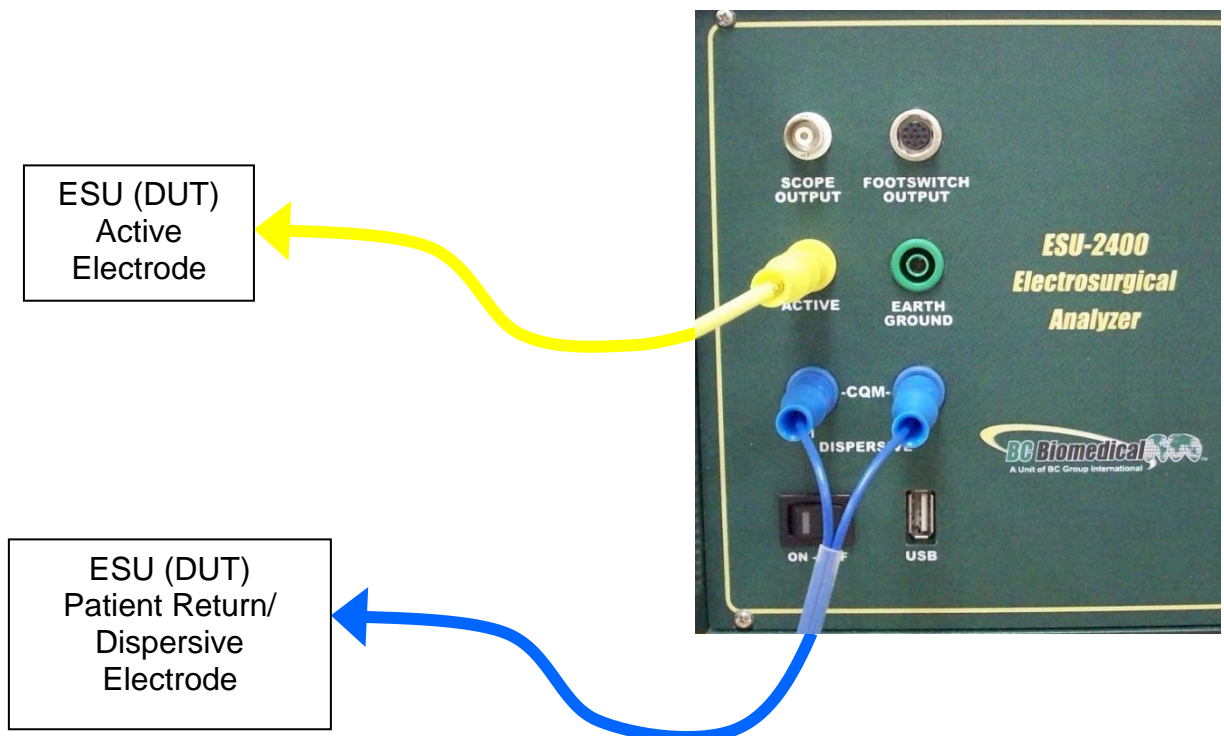

Leakage 3 This leakage test, specified by the IEC as Earth Reference Leakage Type BF (Load from Active Electrode to Earth) is for testing the leakage to earth ground of a Ground Referenced Output type BF electrosurgical generator from the active output. This test complies with IEC 601.2.2, sec. 19.101a, test 2, fig. 102, and sec. 19.102, adopted by ANSI/AAMI HF18-2001. The purpose of this test is to verify that the RF leakage of the Device Under Test (DUT) meets or exceeds the IEC specification.

Connections

1. Active Lead from Active Jack on ESU-2400 to DUT Active Output.
2. Dispersive Lead from Dispersive Jack on ESU-2400 to DUT Dispersive.

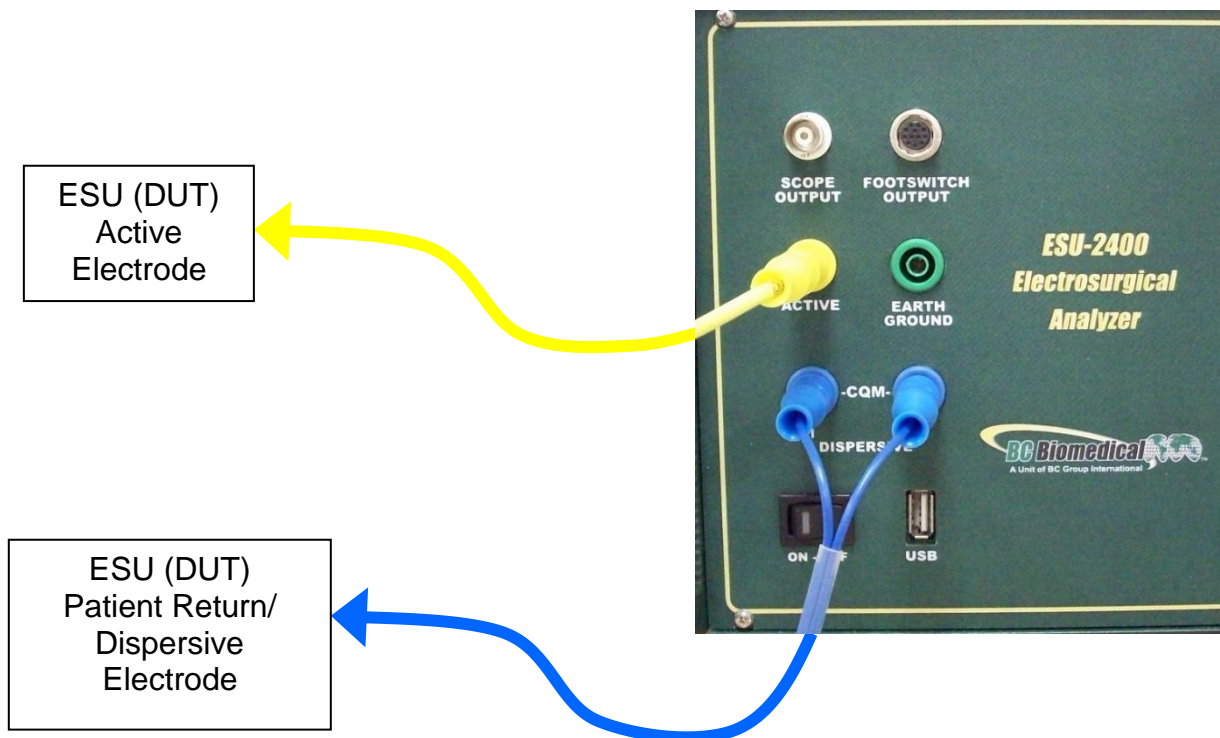

GETTING STARTED

This section was written to help you get started with the ESU-2400. Examples are given for typical configurations of RF Measurement, REM/ARM/CQM testing, Load Curves and Autosequences. This section will give specific examples of how to configure the ESU-2400 plus additional modifications that might help fulfill your specific testing requirements.

MEASURE RF ENERGY

Scenario 1 – I need to measure monopolar current with a 500 ohm load. I don't have a footswitch cable, so I will trigger the DUT myself.

Solution -

1. Select Measure RF Energy from the main menu.
2. Connect the Active output from the DUT to the Active input on the ESU-2400. If you are using the cables from the ESU-2400 accessory kit, use the Yellow Lead.
3. Connect the Dispersive or Return port on the DUT to the Dispersive 1 and Dispersive 2 inputs on the ESU-2400. If you are using the cables from the ESU-2400 accessory kit, use the Blue cable without the pin.
4. Press the Isolated Generator Type button to configure the ESU-2400 for isolated generator measurements.

NOTE: To see how the ESU-2400 is internally configured, press the Test Setup button. To close the image, press Test Setup again.

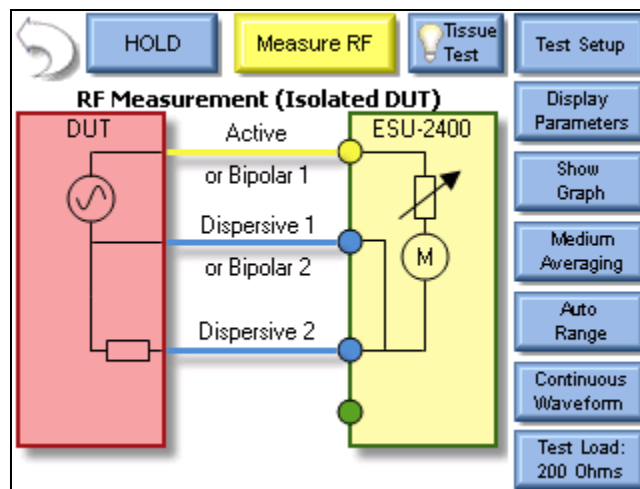

5. Press the Test Load button to open the load configuration box. The screen should look like the following:

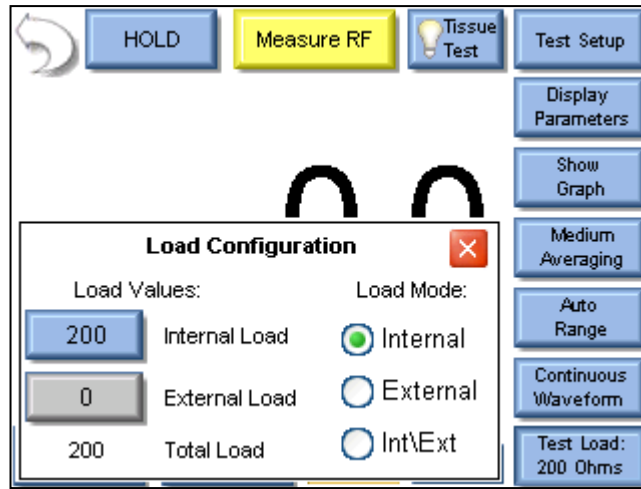

NOTE: The ESU-2400 can be configured to use internal loads, external loads, or a combination of both. First select the Load Mode, then enter the desired internal and external loads. The total load will automatically be updated. For most testing, the internal loads will be sufficient.

6. Press the Button next to Internal Load and enter 500 in the number pad. The system should return to the Measure RF screen.
7. Key the DUT. The mA measurement will be shown on the ESU-2400 Screen.

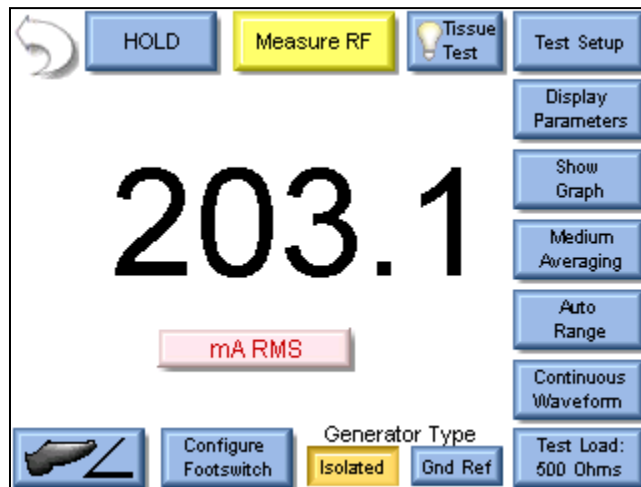

NOTE: The displayed measurement can be changed by pressing the mA RMS button. There are many measurements that can be displayed.

Scenario 2 – I need to measure mA and Watts of a Bipolar output with a 300 ohm Load. I want the ESU-2400 to trigger the DUT with the footswitch output.

Solution -

1. Select Measure RF Energy from the main menu.
2. Connect one Bipolar output from the DUT to the Active input on the ESU-2400. If you are using the cables from the ESU-2400 accessory kit, use the Yellow Lead.
3. Connect the other Bipolar output port from the DUT to the Dispersive 1 input on the ESU-2400. If you are using the cables from the ESU-2400 accessory kit, use the Blue cable with banana jacks on each end, not the CQM/RECQM cable .
4. Press the Test Load button to open the load configuration box. The screen should look like the following:

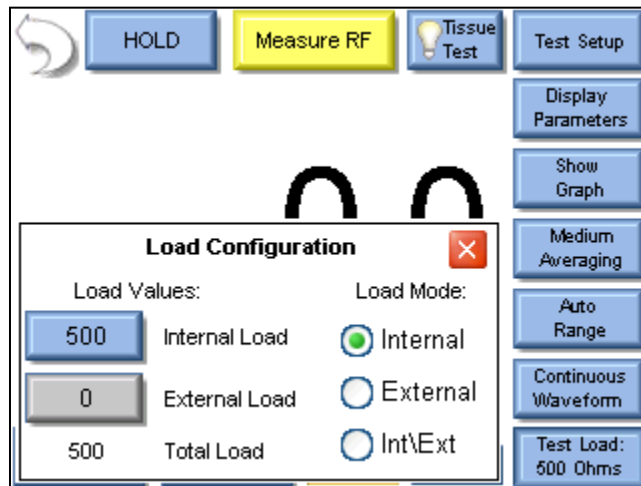

5. Press the Button next to Internal Load and enter 300 in the number pad. The load configuration box should automatically close.

6. Press the Display Parameters button and select Two Readings from the Select Screen menu.

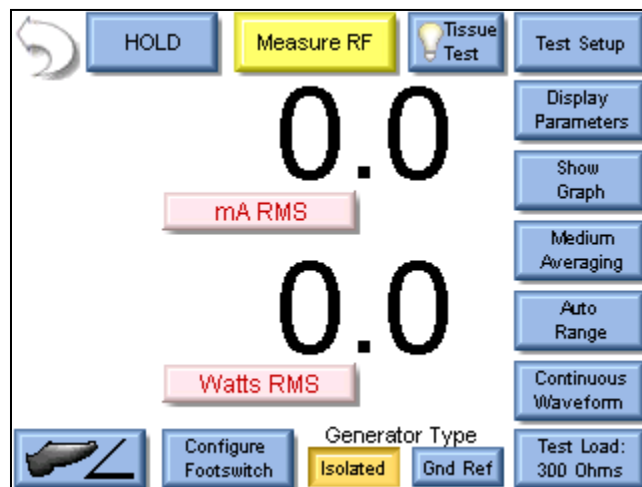
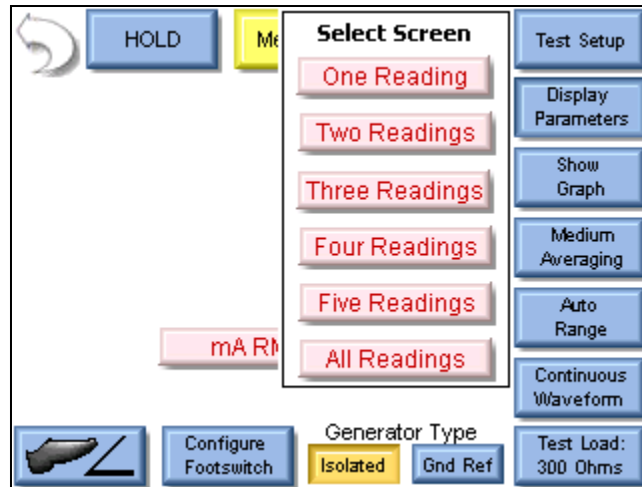

NOTE: By default mA RMS and Watts RMS are shown when Two Readings are selected. Each position can display any of the ESU-2400 measurements by pressing the corresponding measurement button.

7. Press the Configure Footswitch button to open the Footswitch Setup box.
8. Use the dropdown arrow under Select Output to select the Bipolar output.
9. Use the dropdown arrow under Activation Timeout to select the maximum time the DUT will be triggered.

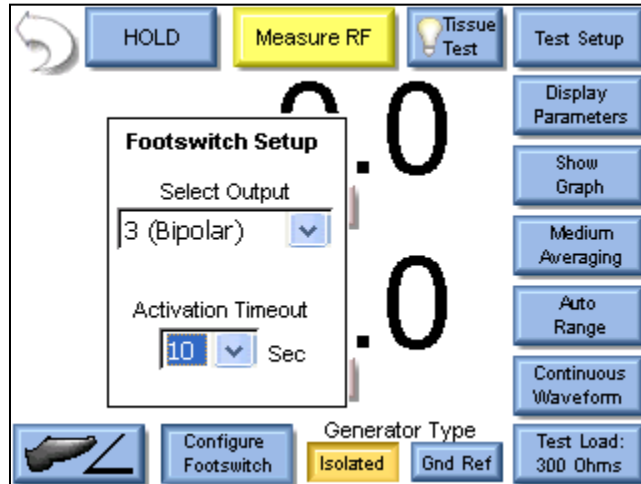

NOTE: The footswitch output selection is only valid for footswitch cables that are designed for a specific DUT, such as the BC20-03001 or BC20-3002. If you are using the unterminated footswitch cable, BC20-03000, the output selection is dependent on how the cable is wired.

10. Press the footswitch button to Key the DUT. The mA and Watts measurements will be shown on the ESU-2400 Screen.

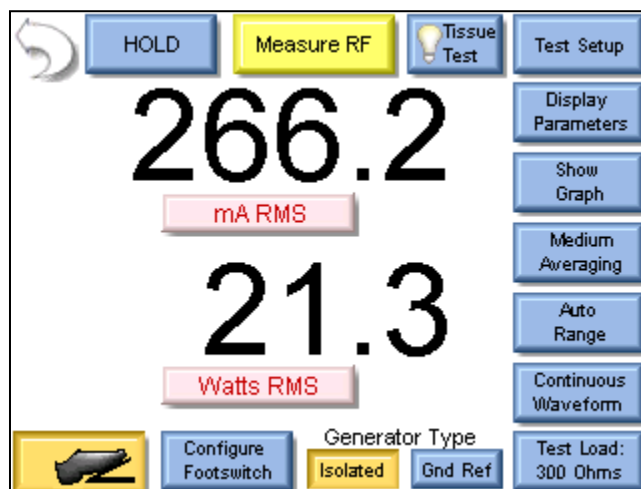

11. You may either wait for the Footswitch Activation Timeout, or press the Footswitch button again to stop keying the DUT output.

Scenario 3 – I need to measure the mA output of a Hyfrecator (ground referenced generator) with a 100 ohm load. I don't have a footswitch cable, so I will trigger the DUT myself.

Solution -

1. Select Measure RF Energy from the main menu.
2. Connect the Active output from the DUT to the Active input on the ESU-2400. If you are using the cables from the ESU-2400 accessory kit, use the Yellow Lead.
3. Press the Gnd Ref generator type button to configure the ESU-2400 to make a ground referenced measurement.

NOTE: To see how the ESU-2400 is internally configured, press the Test Setup button. To close the image, press Test Setup again.

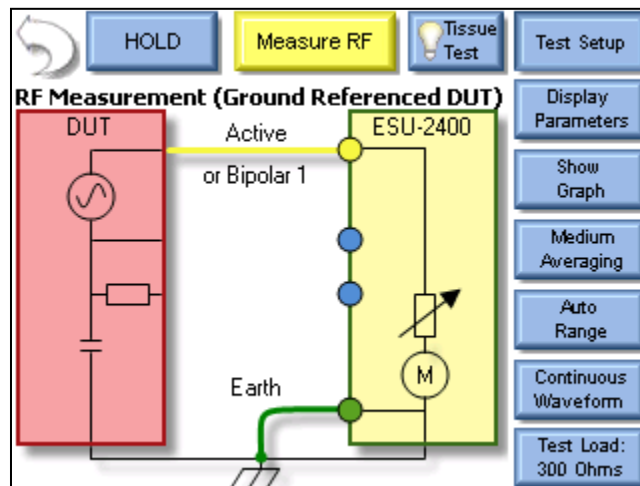

4. Press the Test Load button to open the load configuration box. The screen should look like the following:

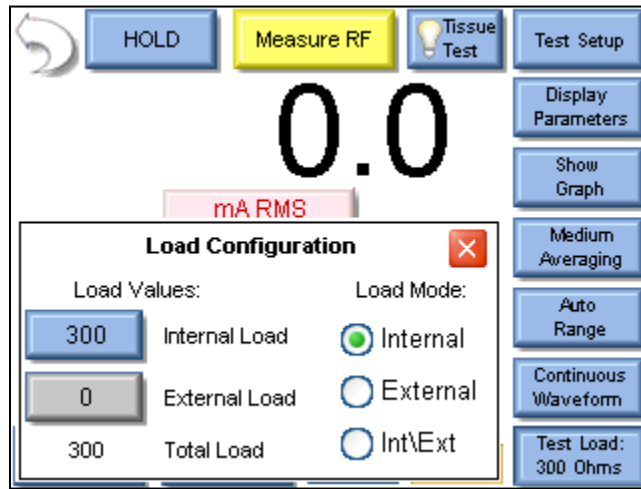

NOTE: The ESU-2400 can be configured to use internal loads, external loads, or a combination of both. First select the Load Mode, then enter the desired internal and external loads. The total load will automatically be updated. For most testing, the internal loads will be sufficient.

5. Press the Button next to Internal Load and enter 100 in the number pad. The screen should automatically return to the Measure RF screen.
6. Key the DUT. The mA measurement will be shown on the ESU-2400 Screen.

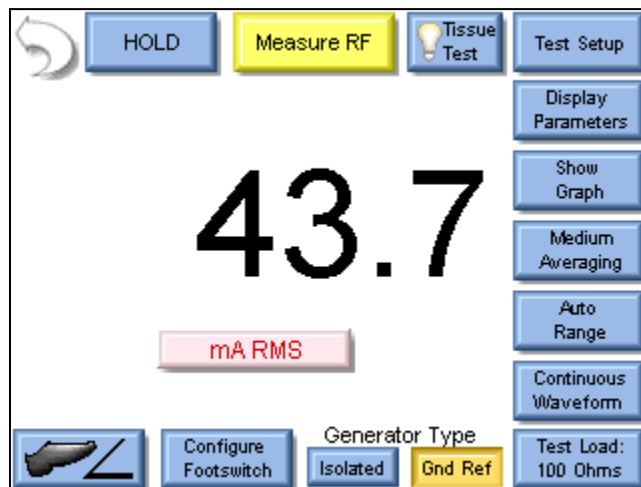

NOTE: The displayed measurement can be changed by pressing the mA RMS button. There are many measurements that can be displayed.

MEASURE RF LEAKAGE

Leakage Test 1a – I need to measure the leakage current from an Active lead to ground of a type CF ESU generator.

Solution -

1. Select Measure RF Leakage from the main menu.
2. If the Leakage selection at the top of the screen does not show Leakage 1a, press the button and select Leakage 1a from the test mode menu.
3. Connect the Active output from the DUT to the Active input on the ESU-2400. If you are using the cables from the ESU-2400 accessory kit, use the Yellow Lead.
4. Connect earth ground port on the ESU-2400 to the ground lug on the back of the DUT. If you are using the cables from the ESU-2400 accessory kit, use the green cable and green alligator clip.

NOTE: To see how the ESU-2400 is internally configured, press the Test Setup button. To close the image, press Test Setup again.

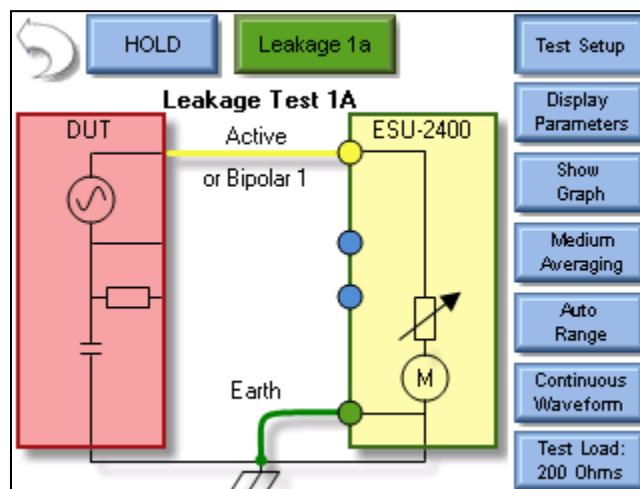

5. Key the DUT. The ESU-2400 will show the mA RMS measurement in the display.

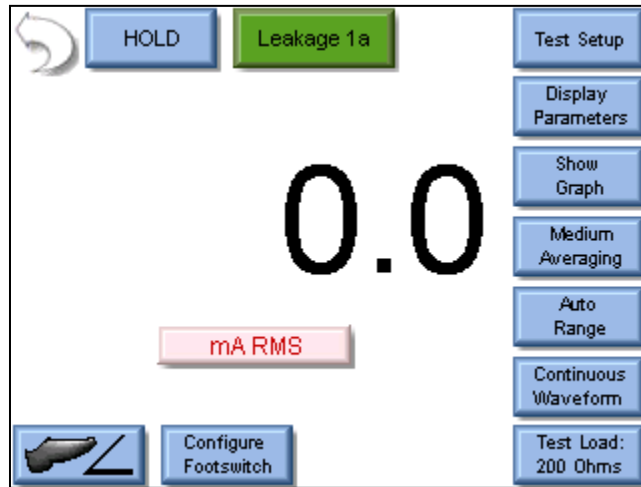

Leakage Test 1b – I need to measure the leakage current from the dispersive (REM) port to ground.

Solution -

1. Select Measure RF Leakage from the main menu.
2. If the Leakage selection at the top of the screen does not show Leakage 1b, press the button and select Leakage 1b from the test mode menu.
3. Connect the Dispersive output from the DUT to the Dispersive inputs on the ESU-2400. If you are using the cables from the ESU-2400 accessory kit, use the Blue cable without the clear pin.
4. Connect earth ground port on the ESU-2400 to the ground lug on the back of the DUT. If you are using the cables from the ESU-2400 accessory kit, use the green cable and green alligator clip.

NOTE: To see how the ESU-2400 is internally configured, press the Test Setup button. To close the image, press Test Setup again.

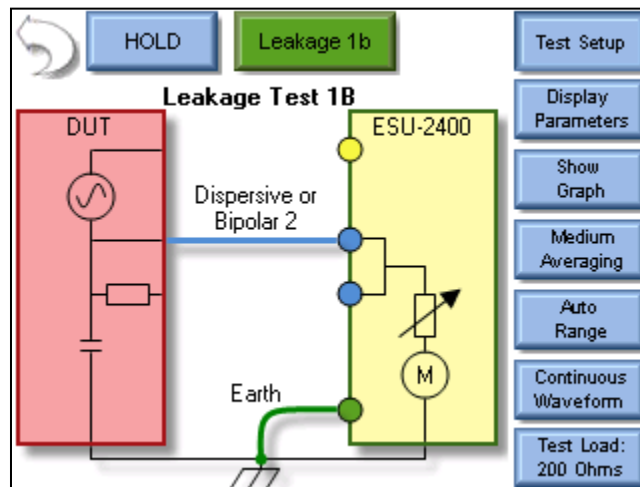

5. Key the DUT. The ESU-2400 will show the mA RMS measurement in the display.

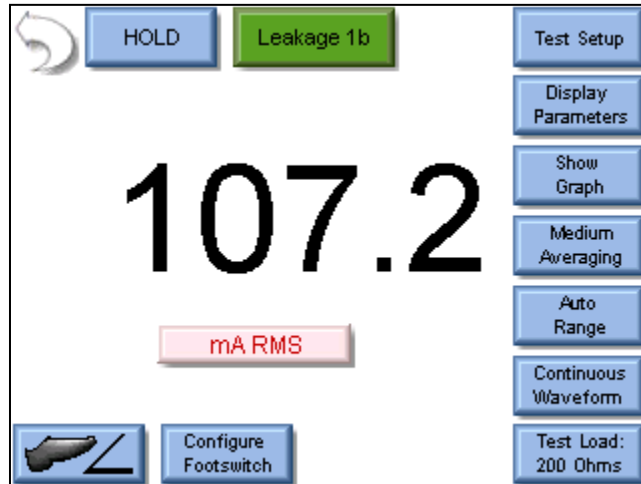

Leakage Test 2– I need to measure the leakage current from the dispersive (REM) port to ground. I need to have a 200 ohm load from Active to Dispersive during the test.

Solution -

1. Select Measure RF Leakage from the main menu.
2. If the Leakage selection at the top of the screen does not show Leakage 2, press the button and select Leakage 2 from the test mode menu.
3. Connect the Active output from the DUT to the Active input on the ESU-2400. If you are using the cables from the ESU-2400 accessory kit, use the Yellow Lead.
4. Connect the Dispersive output from the DUT to the Dispersive inputs on the ESU-2400. If you are using the cables from the ESU-2400 accessory kit, use the Blue cable without the clear pin.
5. Connect earth ground port on the ESU-2400 to the ground lug on the back of the DUT. If you are using the cables from the ESU-2400 accessory kit, use the green cable and green alligator clip.

NOTE: To see how the ESU-2400 is internally configured, press the Test Setup button. To close the image, press Test Setup again.

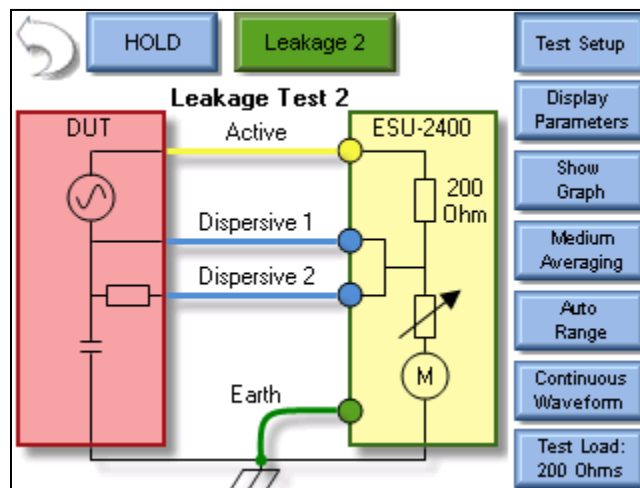

6. Key the DUT. The ESU-2400 will show the mA RMS measurement in the display.

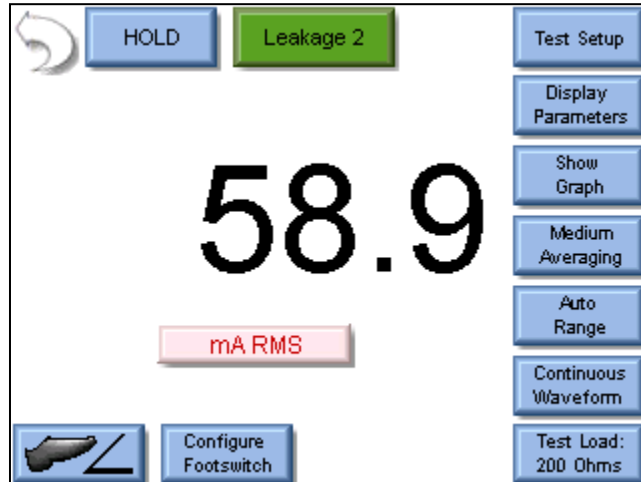

Leakage Test 3 - I need to measure the leakage current from the dispersive (REM) port to ground. I need to have a 200 ohm load from Active to Ground during the test.

Solution -

1. Select Measure RF Leakage from the main menu.
2. If the Leakage selection at the top of the screen does not show Leakage 3, press the button and select Leakage 3 from the test mode menu.
3. Connect the Active output from the DUT to the Active input on the ESU-2400. If you are using the cables from the ESU-2400 accessory kit, use the Yellow Lead.
4. Connect the Dispersive output from the DUT to the Dispersive inputs on the ESU-2400. If you are using the cables from the ESU-2400 accessory kit, use the Blue cable without the clear pin.
5. Connect earth ground port on the ESU-2400 to the ground lug on the back of the DUT. If you are using the cables from the ESU-2400 accessory kit, use the green cable and green alligator clip.

NOTE: To see how the ESU-2400 is internally configured, press the Test Setup button. To close the image, press Test Setup again.

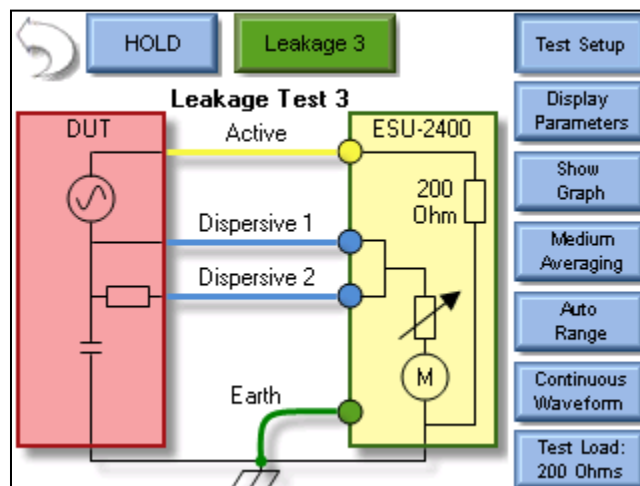

6. Key the DUT. The ESU-2400 will show the mA RMS measurement in the display.

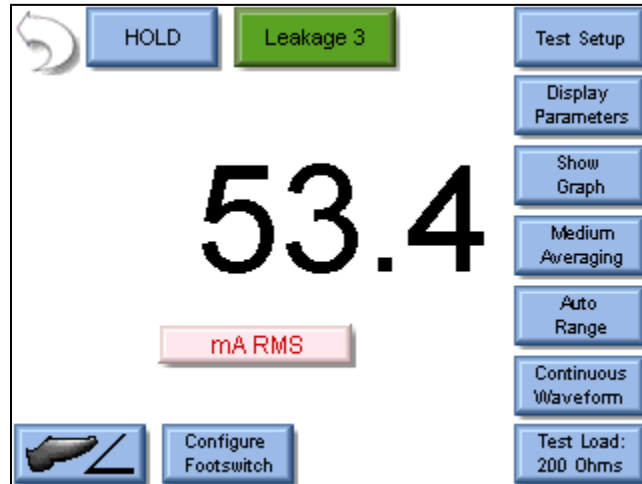

REM/ARM/CQM TEST

Scenario 1 – I need to test the REM function on my generator. The service manual says that the REM alarm should be Normal at 35 ohms.

Solution -

1. Select REM/ARM/CQM from the main menu.
2. Press the CQM Resistance button and enter 35 in the number pad. The screen should look like the following:

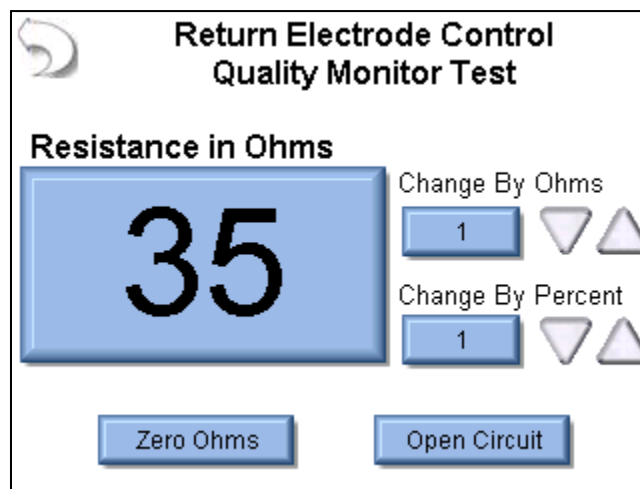

3. Connect the Dispersive output from the DUT to the Dispersive inputs on the ESU-2400. If you are using the cables from the ESU-2400 accessory kit, use the Blue cable with the clear pin.
4. The DUT REM state should be Normal.

Scenario 2 - I need to test the REM function on my generator. The service manual says that the REM alarm should occur if the resistance increases by 40%.

Solution -

1. Select REM/ARM/CQM from the main menu.
2. Press the CQM Resistance button and enter a resistance that should result in a normal CQM state, in this example we will use 50 ohms.
3. Press the Change By Percent button and enter 40 in the number pad. The screen should look like the following:

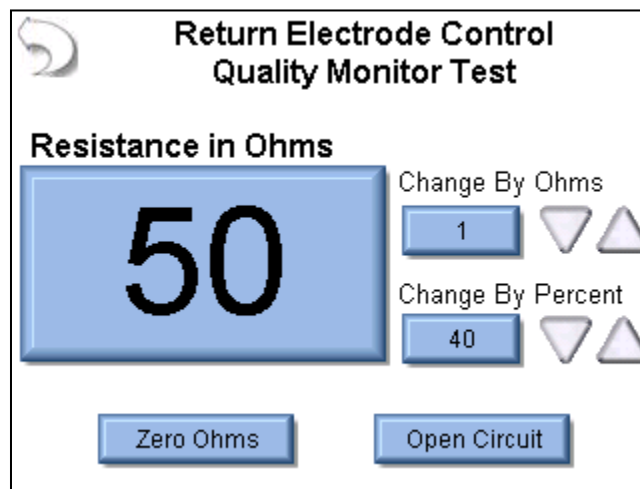

4. Connect the Dispersive output from the DUT to the Dispersive inputs on the ESU-2400. If you are using the cables from the ESU-2400 accessory kit, use the Blue cable with the clear pin.
5. The DUT REM state should be Normal.
6. Press the Up arrow under the Change By Percent heading. The resistance will change to 70 ohms and the DUT should indicate a REM alarm.

LOAD CURVES

Load Curve Scenario 1 – I need to run a bipolar load curve at 60 Watts with loads from 100 to 1000 ohms, measuring every 100 ohms. I am testing a ForceFx generator and want the ESU-2400 to automatically configure and trigger the DUT.

Solution –

1. Select Load Curves from the main menu.
2. Select Configure Load Curve from the Load Curve Menu.
3. Press The Setup Loads tab at the top of the screen to configure the Loads

Setup Loads | Setup Power | Meter | DUT

Step Based Loads List Based Loads

First Load 50 Ohms

Last Load 6400 Ohms

Step Loads By 50 Ohms

10 Total Steps in Test

Save Configuration Start Load Curve

4. Press the Load resistance setting for the First Load and enter 100 in the number pad.
5. Press the Load resistance setting for the Last Load and enter 1000 in the number pad.
6. Press the resistance setting in the Step Loads By option and enter 100 in the number pad. The screen should now look like the following:

Setup Loads | Setup Power | Meter | DUT

Step Based Loads List Based Loads

First Load 100 Ohms

Last Load 1000 Ohms

Step Loads By 100 Ohms

10 Total Steps in Test

Save Configuration Start Load Curve

7. Press the Setup Power tab at the top of the screen to configure the power setting for the test.
8. Select the Single Power Level tab to configure the test for one power setting.
9. Press the DUT Power setting button and enter 60 in the number pad. The screen should look like the following:

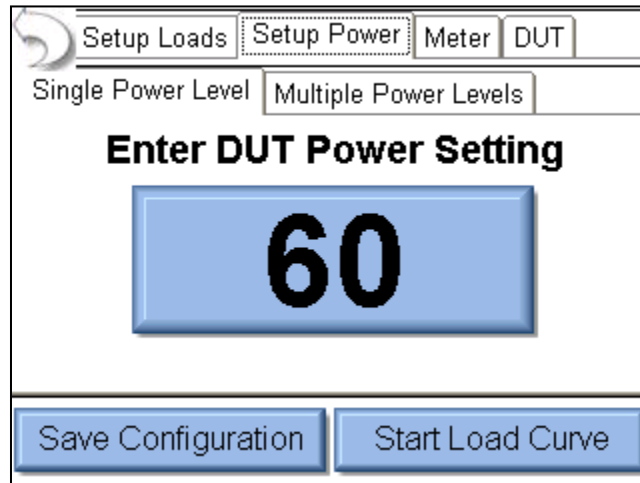

10. Press the DUT tab at the top of the screen to configure the settings for the DUT trigger.
11. Select the ESU-2400 option for DUT activation. This will enable features for configuring the DUT setup. The screen should look like the following:

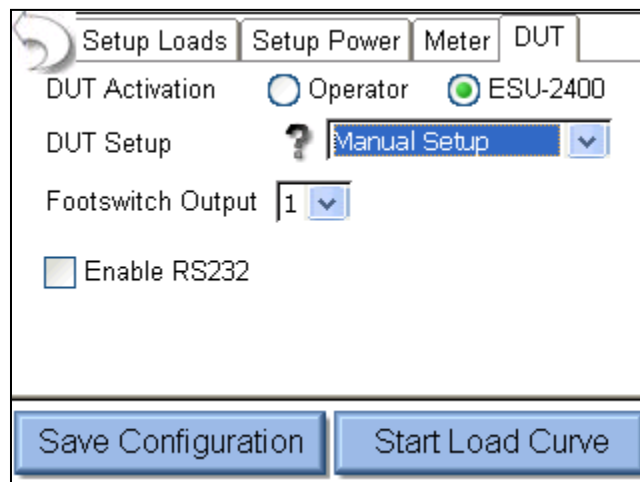

12. For the DUT setup press the dropdown arrow next to Manual Setup to select Setup By Model.
13. Use the dropdown arrow to set the DUT Output to Bipolar.

14. Use the dropdown arrow to set the DUT mode to the desired bipolar output mode. The screen should now look like the following:

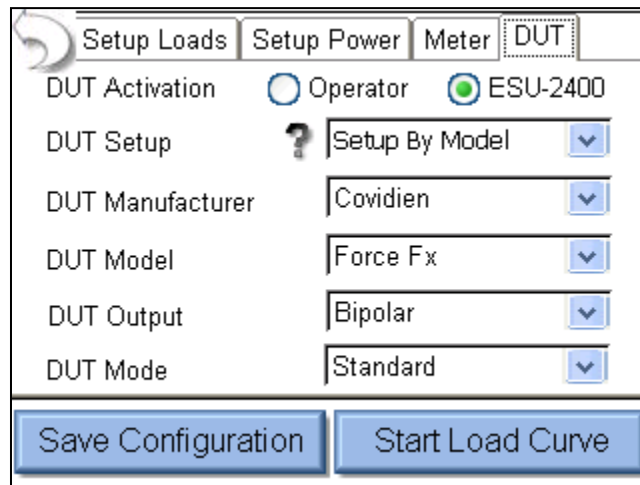

The screenshot shows a software interface with a tabbed menu at the top containing 'Setup Loads', 'Setup Power', 'Meter', and 'DUT'. The 'DUT' tab is active. Below the tabs, there are several configuration options:

- DUT Activation:** Two radio buttons are present: 'Operator' (unselected) and 'ESU-2400' (selected).
- DUT Setup:** A dropdown menu with a question mark icon, currently set to 'Setup By Model'.
- DUT Manufacturer:** A dropdown menu set to 'Covidien'.
- DUT Model:** A dropdown menu set to 'Force Fx'.
- DUT Output:** A dropdown menu set to 'Bipolar'.
- DUT Mode:** A dropdown menu set to 'Standard'.

At the bottom of the interface, there are two blue buttons: 'Save Configuration' and 'Start Load Curve'.

15. Connect the ESU-2400 to the DUT. Connect the Yellow cable from the Active port on the ESU-2400 to one of the Bipolar outputs on the DUT. Connect the Green cable from the Dispersive 1 port of the ESU-2400 to the other Bipolar output on the DUT.
16. Connect the RS-232 cable from the ESU-2400 serial port to the DUT serial port.
17. Connect the BC20-03001 footswitch cable from the DUT to the ESU-2400.
18. Press Save configuration on the ESU-2400 to save the Load Curve settings to a file for future use, or Press Start Load Curve to begin the test. The DUT power level and output mode will automatically be configured through the RS-232 port.

Load Curve Scenario 2 – I need to run a pure cut 300 Watt load curve, but there isn't a footswitch cable available for my DUT. I need to test my DUT at 50, 300, 500, 800, and 1500 ohms.

Solution –

1. Select Load Curves from the main menu.
2. Select Configure Load Curve from the Load Curve Menu.
3. Press The Setup Loads tab at the top of the screen to configure the Loads
4. Select the List Based Loads option to configure the list of loads to be used for the test.

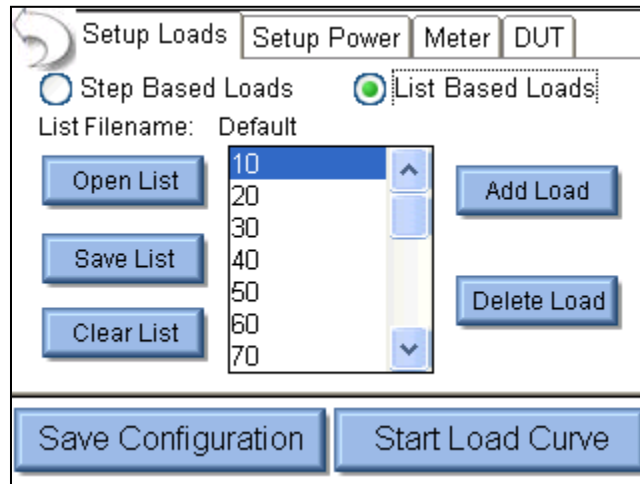

5. Press Clear List to remove all of the previous settings from the list of loads to be used.
6. Press the Add Load button and enter 50 in the number pad.
7. Press the Add Load button again and enter the values for the other loads to be used; 300, 500, 800, 1500. The loads do not need to be entered in sequence, they will automatically be sorted as they are entered. If an incorrect load is accidentally entered, select the incorrect load by pressing on it and then press the Delete Load button, it will be removed from the list. The screen should now look like the following:

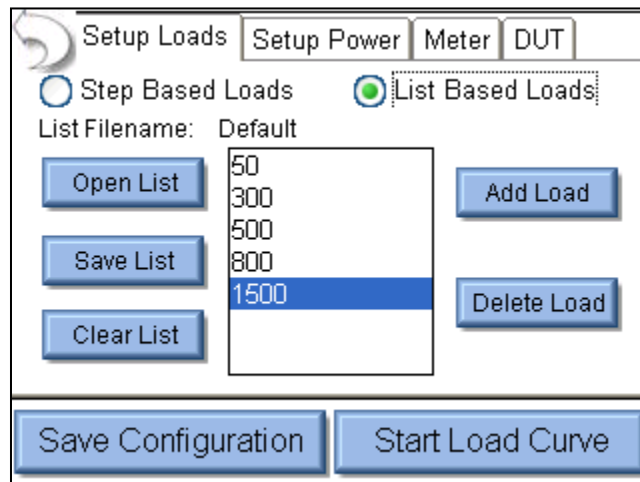

8. Press the Setup Power tab at the top of the screen to configure the power setting for the test.
9. Select the Single Power Level tab to configure the test for one power setting.
10. Press the DUT Power setting button and enter 300 in the number pad. The screen should look like the following:

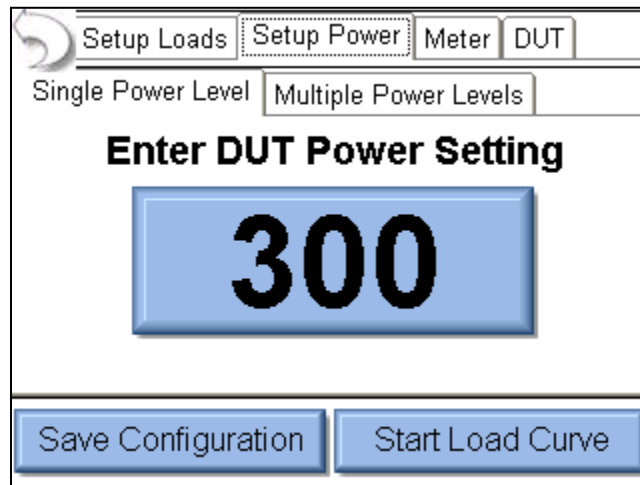

11. Press the DUT tab at the top of the screen to configure the settings for the DUT trigger.
12. Select the Operator option for DUT activation.

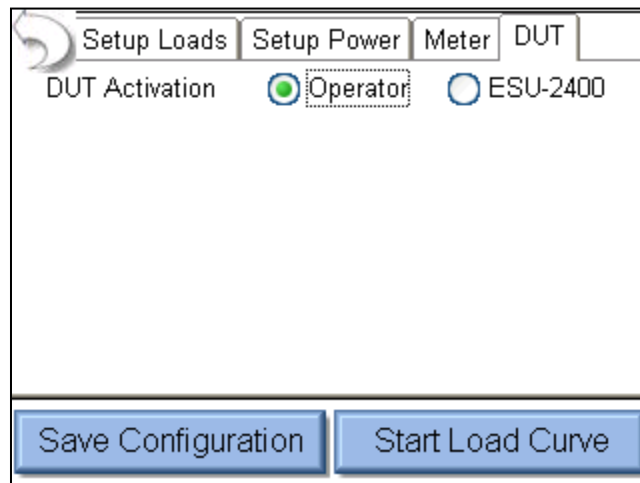

13. Connect the ESU-2400 to the DUT. Connect the Yellow cable from the Active port on the ESU-2400 to active output on the DUT. Connect the Blue cable from the Dispersive ports of the ESU-2400 to the return on the DUT.
14. Press Save Configuration on the ESU-2400 to save the Load Curve settings to a file for future use, or Press Start Load Curve to begin the test. You will be prompted when to start and stop keying the generator.

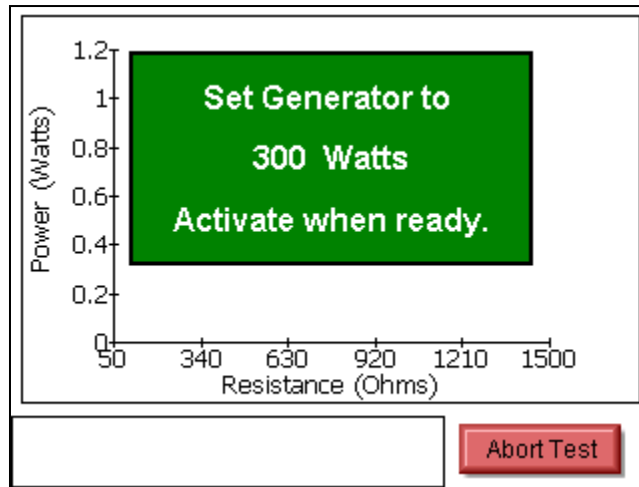

AUTOSEQUENCES

RF Measure: I need to configure an Autosequence step to take an RF current measurement with a 200 ohm load. My measurement tolerance is 315mA, ± 25 mA.

Solution –

1. From the Autosequence menu, select Create New Sequence. Then press Add Step.
2. Select the desired location for the new step and press OK.
3. The new step will always default to an instruction type step. Select the RF Energy / Leakage option button near the bottom of the screen.
4. Press the title Text box to change the step title as desired. You will need to use an external keyboard for this.
5. Press the Instructions to Operator text box to enter any instructions that the user might need to perform at this step of the autosequence.

The screenshot shows a configuration dialog box for an autosequence step. At the top, there is a text box labeled "Title:" containing the text "Monopolar 1 Pure Cut, 200 Ohms". Below this is a section titled "Enter Instructions to Operator Below" which contains a scrollable text area with the following instructions: "DUT output.", "2) Connect the blue cable from the Dispersive ports on the ESU-2400 to the DUT REM port.", and "3) Set the DUT for 100 Watts, pure cut mode.". Below the scrollable area are four radio button options: "Instruction Only", "Load Curve", "RF Energy/Leakage" (which is selected), and "REM/ARM/CQM". At the bottom of the dialog are four buttons: "DUT Setup", "Meter Setup", "Done", and "Cancel".

6. Press the Meter Setup button to configure the measurement mode and tolerance.

7. Press the Test Load button to open the Load Configuration menu.
8. Press the Internal Load value button to change the internal load to 200 ohms. By default, the user will not be able to change the load resistance once the test is running. If you would like for the operator to be able to change the load, check the box next to Allow Operator to modify load.

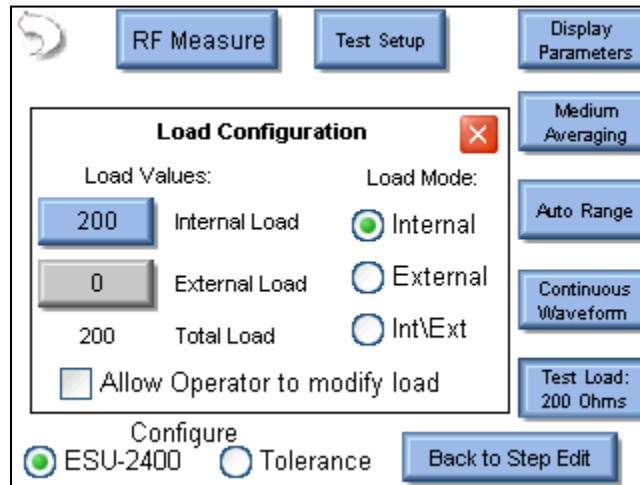

9. Press the Test Load button again or the Red X button to close the Load Configuration menu.
10. Press the Tolerance option button at the bottom of the screen to configure the tolerance for the RF measurement.
11. The DUT output mode and output type and power setting can be selected at the top of the screen. These are informational only and do not have any effect on the test or measurement.
12. Use the dropdown arrow under Expected Reading to change the tolerance mode to Equal to (Value).
13. Press the number button to the right of the expected reading and enter 315 in the number pad. Additionally, if the desired reading were watts or any other measurement taken by the ESU-2400, the red button to the right of the expected reading can be pressed to change the measurement being tested.
14. Press the number button for High Limit and set the value to 25 with the number pad.
15. Press the number button for Low limit and set the value to 25 with the number pad.

16. Additionally, if you would like to allow the user to override the automated limit testing, you can check the box next to Allow operator to select Pass/Fail status.
17. The screen should look like the following; the configuration is complete for this step. Press Back to Step Edit and then Done to return to the Autosequence Summary screen.

RF Measurement Limits

DUT Output: Monopolar (dropdown)
DUT Mode: Cut (dropdown)

DUT Power Setting: 100

Expected Reading: Equal To (Value) 315 mA RMS

High Limit: + 25 (340 mA)
Low Limit: - 25 (290 mA)

Allow operator to select Pass/Fail Status

Configure
 ESU-2400 Tolerance

Back to Step Edit

Load Curve– I need to run a pure cut 300 Watt load curve, and there isn't a footswitch cable available for my DUT. I need to take 10 measurements with loads from 50 to 5000 ohms.

Solution –

1. From the Autosequence menu, select Add Step.
2. Select the desired location for the new step and press OK.
3. The new step will always default to an instruction type step. Select the Load Curve option button near the bottom of the screen.
4. Press the Title text box to change the step title as desired. You will need to use an external keyboard for this.
5. Press the Instructions to Operator text box to enter any instructions that the user might need to perform at this step of the autosequence.

Title: Load Curve

Enter Instructions to Operator Below

This step will run a load curve at 300 watts with 10 loads ranging from 50 to 5000 ohms.

Instruction Only Load Curve
 RF Energy/Leakage REM/ARM/CQM

DUT Setup Meter Setup Done Cancel

6. Press the Meter Setup button to configure the load curve.
7. Press The Setup Loads tab at the top of the screen to configure the Loads

8. Press the Load resistance setting for the First Load and enter 50 in the number pad.
9. Press the Load resistance setting for the Last Load and enter 5000 in the number pad.
10. Press the resistance setting in the Total Steps in Test option and enter 10 in the number pad. The screen should now look like the following:

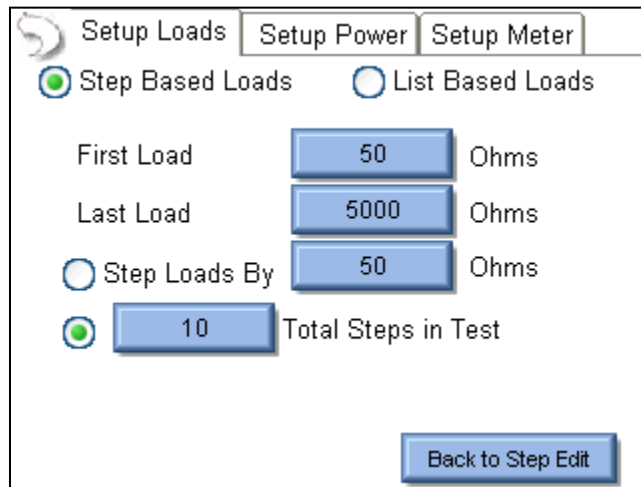

11. Press the Setup Power tab at the top of the screen to configure the power setting for the test.
12. Select the Single Power Level tab to configure the test for one power setting.
13. Press the DUT Power setting button and enter 300 in the number pad. The screen should look like the following:

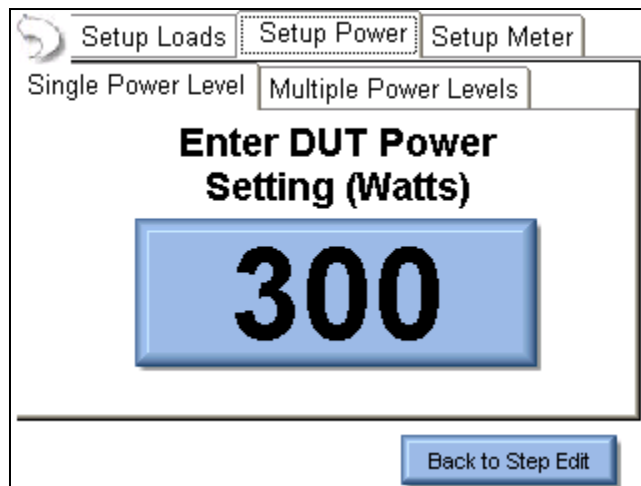

14. The configuration is complete for this step. Press Back to Step Edit and then Done to return to the Autosequence Summary screen.

Auto CQM– I need to test the CQM input on my generator. My generator service manual says to increase the CQM resistance starting at 120 ohms until the CQM alarm occurs. The CQM trip resistance should be 135 ohms +/- 5 ohms.

Solution –

1. From the Autosequence menu, select Add Step.
2. Select the desired location for the new step and press OK.
3. The new step will always default to an instruction type step. Select the REM/ARM/CQM option button near the bottom of the screen.
4. Press the Title text box to change the step title as desired. You will need to use an external keyboard for this.
5. Press the Instructions to Operator text box to enter any instructions that the user might need to perform at this step of the autosequence.

The screenshot shows a software dialog box with the following elements:

- Title:** A text box containing "Auto CQM 120 to 135 Ohms".
- Enter Instructions to Operator Below:** A scrollable text area containing the instruction: "Connect the REM cable from the ESU-2400 dispersive ports to the DUT REM port. Be sure to use the blue cable with the clear pin on the DUT connector."
- Radio Buttons:** Four radio buttons are located at the bottom of the dialog:
 - Instruction Only
 - Load Curve
 - RF Energy/Leakage
 - REM/ARM/CQM
- Buttons:** Three buttons are located at the bottom right: "Meter Setup", "Done", and "Cancel".

6. Press the Meter Setup button to configure the settings for the REM test.
7. Select the Auto CQM option at the top of the screen.

- Select the Step Values tab to configure the CQM resistance to be used. The screen should look like the following:

The screenshot shows a control panel for CQM configuration. At the top, there are two radio buttons: 'Manual CQM' (unselected) and 'Auto CQM' (selected). Below this are three tabs: 'Single Value', 'Step Values' (selected), and 'List Values'. The 'Step Values' tab contains several input fields and checkboxes:

- 'First Load' with a value of 120 Ohms.
- 'Last Load' with a value of 145 Ohms.
- 'Step Loads By' with a value of 1 Ohms.
- 'Total Steps in Test' with a value of 10.
- Two checkboxes: 'Stop when CQM is normal' (unselected) and 'Stop when CQM alarm occurs' (selected).
- A 'Set Tolerance' button.
- Two checkboxes: 'Auto Advance on Pass' (unselected) and 'Auto Start CQM Test' (unselected).
- A 'Back to Step Edit' button.

- Press the First Load button and enter 120 in the number pad.
- Press the Last Load button and enter 145 ohms.
- Press the Step Loads By button and enter 1 in the number pad.
- Select the option button for Stop when CQM alarm occurs.
- Press the Set Tolerance button to configure the Pass/Fail limits for the test. Since the requirement is to alarm at 135 ± 5 ohms, set the CQM Trip point for 135 ohms.
- Press the Trip Upper limit button and enter 140 in the number pad.
- Press the Trip Lower limit button and enter 130 ohms in the number pad. The screen should look like the following:

The screenshot shows the 'Setup CQM Validation Requirements' screen. It features the same top controls as the previous screen: 'Manual CQM' (unselected) and 'Auto CQM' (selected) radio buttons, and 'Single Value', 'Step Values' (selected), and 'List Values' tabs. The main content area is titled 'Setup CQM Validation Requirements' and includes:

- 'CQM Trip Point' with a value of 135 Ohms.
- 'Trip Upper Limit' with a value of 140 Ohms.
- 'Trip Lower Limit' with a value of 130 Ohms.
- An 'OK' button.
- Two checkboxes: 'Auto Advance on Pass' (unselected) and 'Auto Start CQM Test' (unselected).
- A 'Back to Step Edit' button.

- Press the OK button to close the validation requirements menu.
- The configuration is complete for this step. Press Back to Step Edit and then Done to return to the Autosequence Summary screen.

MAIN SCREEN

The ESU-2400 boots to the main screen by default. The power up screen can be changed in the System Setup screen. The main screen provides a quick way to select the desired operating mode.

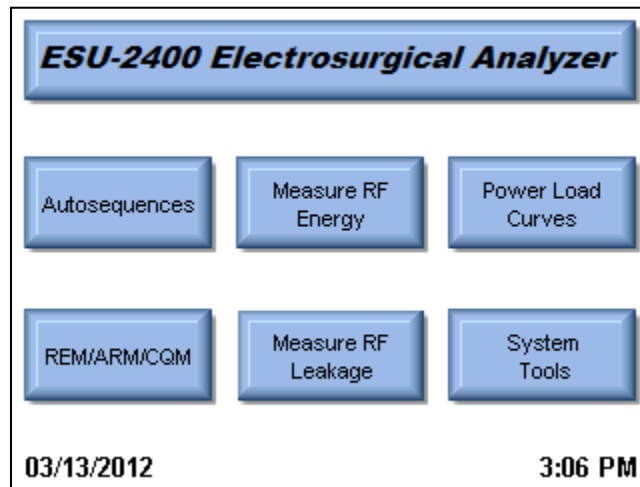

Autosequences

This mode provides for automated DUT testing. Autosequences can consist of any combination of user instructions, RF measurements, Load Curves, or CQM tests. Autosequences can be edited, loaded, and saved to either on board memory or external USB flash drives.

Measure RF Energy

This mode provides for RF measurements. The user can configure the ESU-2400 for the desired RF measurement including Pulsed/Continuous waveform measurement, load setting, etc.

Power Load Curves

This mode provides for automated load curve testing of the DUT. Load curves can be configured for multiple load values and power levels.

REM/ARM/CQM

This mode allows the user to test the REM/ARM/CQM function of the DUT. The resistance can be manually entered, adjusted by a specific resistance, or adjusted by a percent of resistance. This mode also has the ability to set the CQM load to an open circuit.

Measure RF Leakage

This mode provides for RF Leakage measurements. The user can configure the ESU-2400 for the desired RF Leakage measurement including Pulsed/Continuous waveform measurement, load setting, etc. All switching for the leakage modes is performed by internal relays.

System Tools

This mode provides for configuration of the ESU-2400. In this mode the user can calibrate the touchscreen, update the system firmware, and adjust settings such as filter rate and system volume.

System Information

The system information screen is shown by pressing the ESU-2400 title bar on the main screen. This window provides the basic information about the system including software versions and calibration due date.

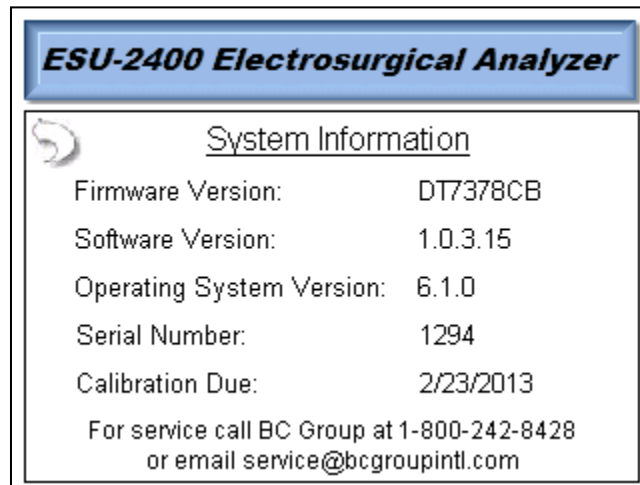

To exit the system information screen, simply press anywhere on the screen.

AUTOSEQUENCES

The autosequence is a programmable procedure for performing testing on a generator. The autosequence can consist of any combination of user instructions, RF measurements, Load Curves, or CQM tests. Once an autosequence is created, it can be saved as a secure sequence, which cannot be modified. The following image shows the main autosequence menu, where the user can load an autosequence, begin a ForceTriad PM, view previously saved test results, or create new autosequences.

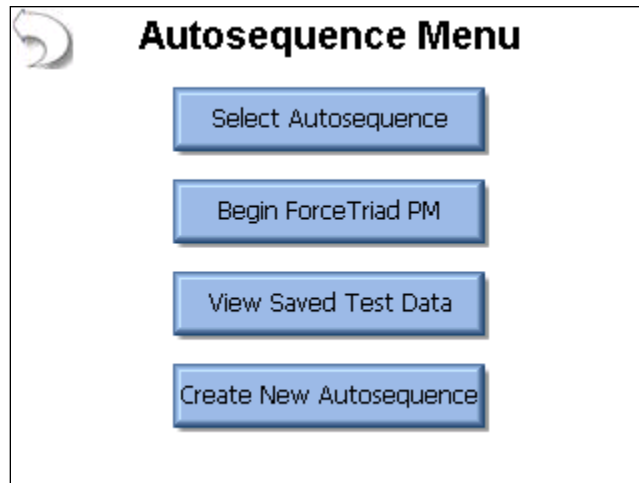

When selecting an autosequence, the user has the option of opening an Autosequence Setup file (*.seq) or a Secure Autosequence (*.ssq) by selecting the filter type in the File Open dialog box (see page 109). The Secure Sequence cannot be modified by the user.

The following screen is shown after opening an autosequence setup file.

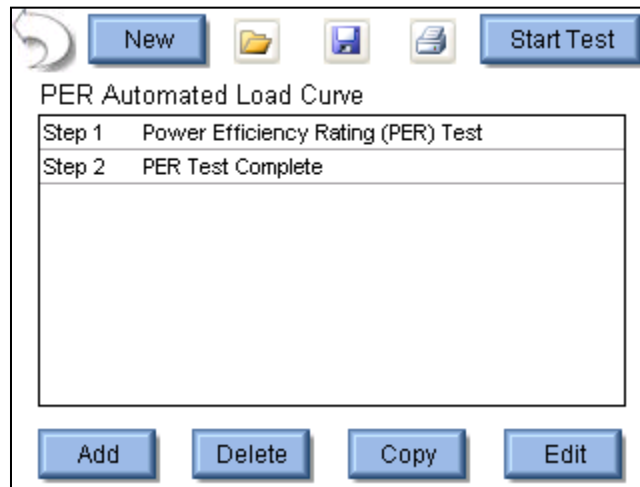

When a step is selected, it is highlighted in blue and expanded to show the step details.

When a step is not selected, the background is white and only the essential details of the step are shown. The following buttons are available in this screen.

New – This button will create a new autosequence.

Open – This button will show the file open dialog box that will open an existing autosequence.

Save – This button will show the file save dialog box. When saving the autosequence, the file Filter can be used to select whether the file is to be a standard Autosequence Setup file (*.seq) or Secure Sequence file (*.ssq). Once a file is saved as a secure sequence it cannot be modified.

Print – This button will display the print menu.

Start Test – This button starts the shown autosequence.

Add Step – This button will show the add step dialog box, shown below. To add a step to the autosequence, select where to add the step and then press OK.

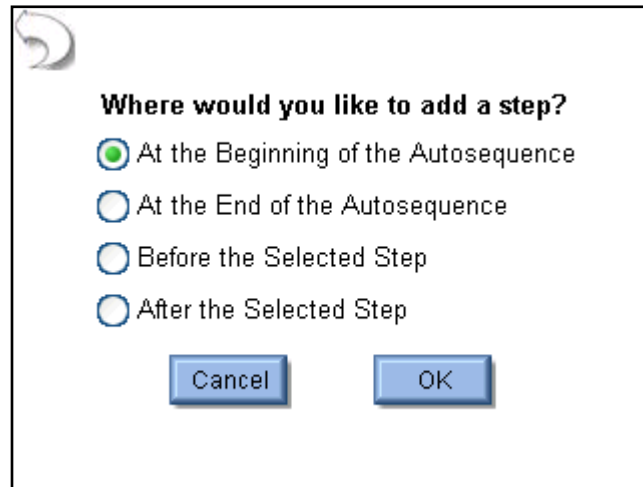

Delete Step – This button will delete the selected step from the autosequence.

Copy Step – This button will copy the selected step. When copying a step the user has the option of where to place the new step.

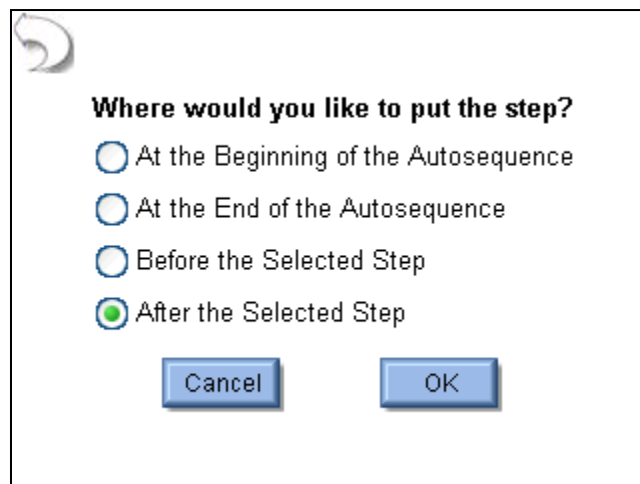

Edit Step– This button will show the edit step window, shown below.

The image shows a dialog box titled "Edit Step". At the top, there is a text input field labeled "Title:" containing the text "Instruction Step". Below this is a section labeled "Enter Instructions to Operator Below" which contains a large, empty text area with a vertical scrollbar on the right side. At the bottom of the dialog, there are four radio button options arranged in two rows: "Instruction Only" (which is selected), "Load Curve", "RF Energy/Leakage", and "REM/ARM/CQM". To the right of these options are two buttons labeled "Done" and "Cancel".

Each step has a field for the step title and instructions to the user. These fields must be entered using an external keyboard or remotely with a PC. Each step can be configured as an Instruction Only, RF Energy / Leakage, Load Curve, or REM/ARM/CQM step by selecting the appropriate option button at the bottom of the step edit screen.

DUT Setup

For RF Energy / Leakage and Load Curve steps, the user needs to configure how the DUT will be activated. For these measurements, the DUT can be activated by the Operator or the ESU-2400 as shown below. When Operator is selected, the user will be prompted when to activate or deactivate the ESU.

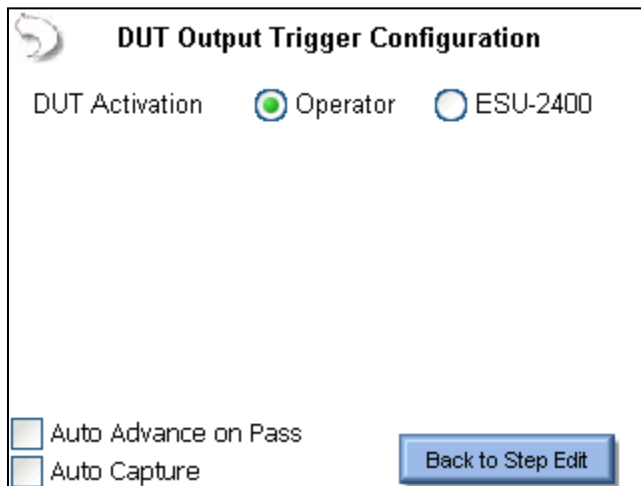

The screenshot shows a dialog box titled "DUT Output Trigger Configuration". It contains the following elements:

- A "DUT Activation" label followed by two radio buttons: "Operator" (which is selected, indicated by a green dot) and "ESU-2400" (which is unselected).
- Two checkboxes at the bottom left: "Auto Advance on Pass" and "Auto Capture", both of which are currently unchecked.
- A blue button at the bottom right labeled "Back to Step Edit".

Auto Advance on Pass – This setting allows for automatically stepping through the autosequence if a measurement passes the tolerance limits that are configured for the selected step.

Auto Capture – When enabled, this setting will automatically capture and validate the DUT output when the current step is reached during the autosequence. If unchecked, the autosequence will show instructions to the user and the user must manually select the meter display and capture an RF measurement.

When ESU-2400 is selected as the trigger source, the activation can be setup manually or by DUT manufacturer and model. For Manual Setup, the user selects the desired footswitch output to be used.

If RS-232 is enabled, the user also selects the baud rate and enters commands to be used for DUT setup and control. When entering commands, use “%P” to represent the power level. In the example below, the ESU-2400 would send the command “:FTP300” when the autosequence power level is set to 300 watts.

DUT Output Trigger Configuration

DUT Activation Operator ESU-2400

DUT Setup ? Manual Setup

Footswitch Output 1

Enable RS232

Auto Advance on Pass

Auto Capture

Back to Step Edit

DUT Output Trigger Configuration

DUT Activation Operator ESU-2400

DUT Setup ? Manual Setup

Footswitch Output 1

Enable RS232

Baud Rate 9600

DUT Commands ?

```
:FTMD  
:FTP%P
```

Auto Advance on Pass

Auto Capture

Back to Step Edit

When the DUT Setup is set to Setup by Model, the user selects the DUT manufacturer and model as well as the desired output mode. The ESU-2400 handles all of the RS-232 and footswitch output setup.

DUT Output Trigger Configuration

DUT Activation Operator ESU-2400

DUT Setup ? Setup By Model

DUT Manufacturer Covidien

DUT Model Force Fx

DUT Output Cut

DUT Mode Low

Auto Advance on Pass

Auto Capture

Back to Step Edit

RF Energy / Leakage Step – All of the options in the standard RF measurement and leakage modes are available in the RF Energy / Leakage step configuration.

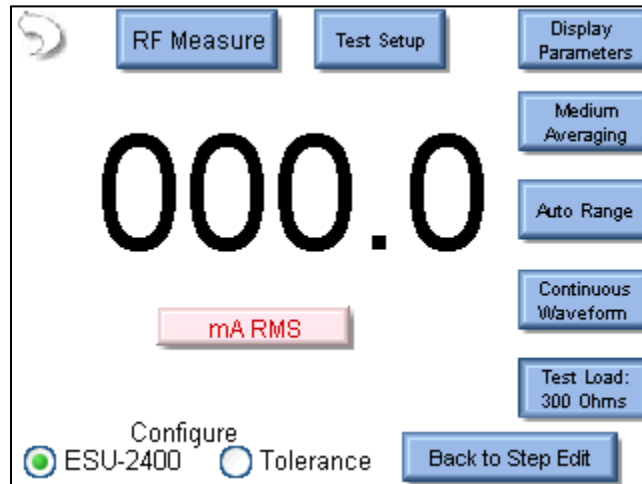

The user must configure both the ESU-2400 meter as well as the measurement tolerance. To setup the tolerance, select the Tolerance option button at the bottom of the screen.

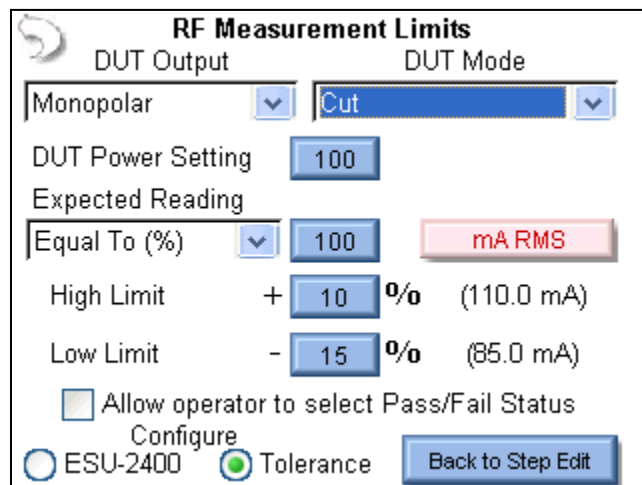

DUT Output Mode – This setting is for display only, to identify to the user the output mode used.

DUT Output Type – This setting is for display only, to identify the type of output to be measured.

DUT Power Setting – This setting represents what the DUT should be set to for the current step.

Expected Reading – This sets how the ESU-2400 determines whether a measurement passes or fails. Available settings are Equal To (%), Less Than, Greater Than, or Equal To (Value).

Measurement Units – The user can press the red units button to select what is to be measured for the current step. Available measurements can be found in the Measure RF Energy chapter, page 72.

High / Low Limit – These settings determine the limits of the measurement. If Expected Reading is set to “Equal To (%)”, the limits will be based on a percentage of the expected reading. If the Expected Reading is set to “Equal To (Value)”, the limits will be based on a measurement offset from the expected reading. The numbers in parenthesis below the measurement units display the reading limits based on expected value settings and High/Low Limits.

Allow Operator to Select Pass/Fail – The tolerances configured on this screen will determine the pass or fail status of the captured measurement during the autosequences. In some cases, it may be useful to allow the user to select the pass/fail status of a particular measurement. If this box is unchecked, the operator will not be allowed to modify the pass/fail status of the measurement.

Load Curve Step – All of the options in the standard load curve are available to the load curve step configuration.

The screenshot shows a software interface for configuring load curves. It features three tabs at the top: 'Setup Loads', 'Setup Power', and 'Setup Meter'. The 'Setup Loads' tab is active. Below the tabs, there are two radio buttons: 'Step Based Loads' (selected) and 'List Based Loads'. Under 'Step Based Loads', there are three input fields: 'First Load' with a value of 50 Ohms, 'Last Load' with a value of 750 Ohms, and 'Step Loads By' with a value of 50 Ohms. There is also a radio button for 'Step Loads By' (unselected) and a radio button for 'Total Steps in Test' (selected) with a value of 20. A 'Back to Step Edit' button is located at the bottom right of the window.

The tabs across the top of the screen allow the user to configure the Loads, Power settings to be used, and the Meter configuration for the Load Curve.

Setup Loads Tab – The loads can be configured as either a step based load change or a list based load change. For the step based loads, the user enters the first load to be used and the last load to be used. Then the ESU-2400 steps the loads by either a fixed resistance or by a calculated amount to achieve a fixed number of steps for the test. In the previous picture, the load curve would start at 50 ohms, and increment the load by

35 ohms $\left(\frac{750-50}{20}\right)$ to provide 20 total steps in the test.

For list based loads, the following screen is shown, allowing the user to select specific resistances to be used for the test.

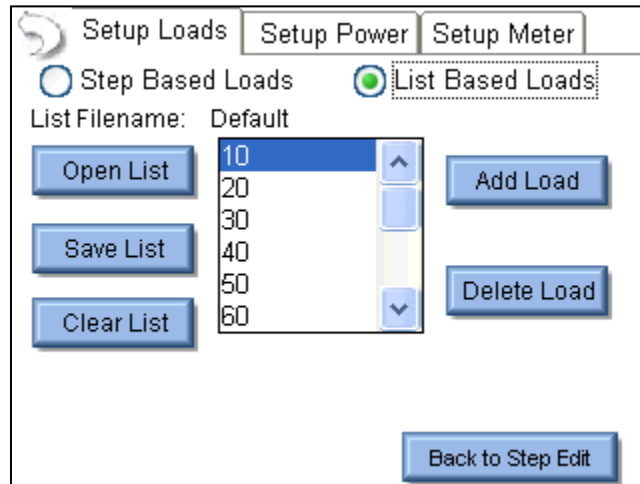

The load configuration list can be saved to a file or loaded from a previously saved list. The loads are automatically sorted by value as they are added to the list.

Single Power Level Tab – For the load curve power configuration, the user can set the ESU-2400 to run the load curve at a single power level or multiple power levels. The following screen shows the configuration for a single power level.

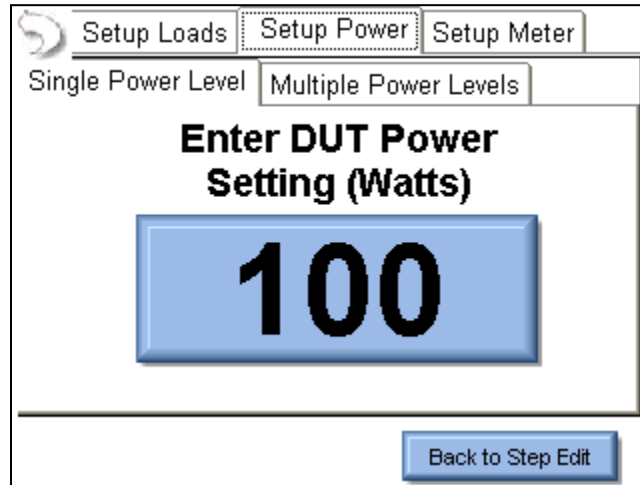

By pressing on the power setting, the user will be able to enter the desired power level for the load curve test.

Multiple Power Levels Tab – When using multiple power levels, the configuration options are similar to the Load config. The user can select either step based power levels based on a fixed change in watts or based on the number of desired steps in the test.

The screenshot shows a software interface with three tabs at the top: 'Setup Loads', 'Setup Power', and 'Setup Meter'. The 'Setup Power' tab is active, and within it, the 'Multiple Power Levels' sub-tab is selected. There are two radio buttons: 'Step Based Power' (which is selected) and 'List Based Power'. Below these are four input fields: 'First Power' with a value of 50 Watts, 'Last Power' with a value of 300 Watts, 'Step Power By' with a value of 50 Watts, and 'Total Steps in Test' with a value of 10. A 'Back to Step Edit' button is located at the bottom right of the window.

For list based power levels, the user can enter any combination of power settings to use for the load curve, as shown below. The power configuration list can be saved to a file or loaded from a previously saved list. The power settings are automatically sorted by value as they are added to the list.

The screenshot shows the same software interface as the previous one, but now the 'List Based Power' radio button is selected. On the left side, there are three buttons: 'Open List', 'Save List', and 'Clear List'. In the center, there is a list box with the filename 'Default' and a list of power values: 50, 100, 150, and 250. The value 50 is currently selected in the list. On the right side, there are two buttons: 'Add Power' and 'Delete Power'. A 'Back to Step Edit' button is located at the bottom right of the window.

Setup Meter Tab – The measurement mode for the load curve can be configured in the Setup Meter Tab. This screen allows for the selection of the Input Range, Input Mode, and Averaging Rate. These settings are adjustable to match the waveform or device being tested.

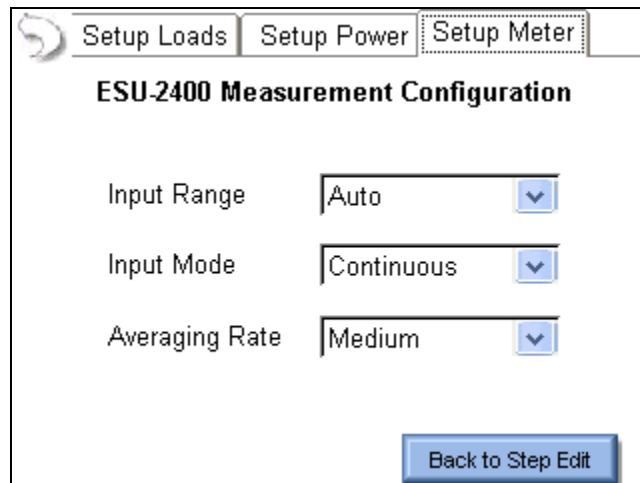

The screenshot displays the 'Setup Meter' tab of the 'ESU-2400 Measurement Configuration' interface. At the top, there are three tabs: 'Setup Loads', 'Setup Power', and 'Setup Meter', with 'Setup Meter' being the active tab. Below the tabs, the title 'ESU-2400 Measurement Configuration' is centered. The main area contains three settings, each with a label and a dropdown menu: 'Input Range' is set to 'Auto', 'Input Mode' is set to 'Continuous', and 'Averaging Rate' is set to 'Medium'. At the bottom right, there is a blue button labeled 'Back to Step Edit'.

For more information on measurement modes, refer to the RF Measurement chapter of the manual on page 72.

Manual CQM Step – CQM autosequence steps can be configured as manual or automatic tests. For manual CQM autosequence steps, the user configures the initial CQM resistance and selects whether the operator will be allowed to modify the CQM resistance. When the test is running, the operator will need to determine whether the CQM test passes or fails.

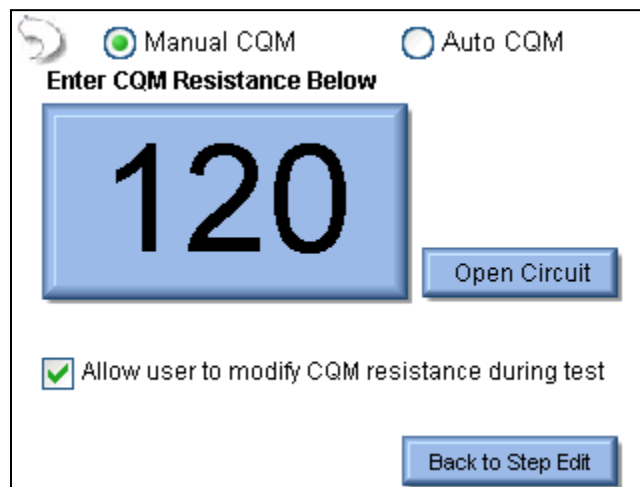

The screenshot displays a software interface for a CQM test. At the top, there are two radio buttons: 'Manual CQM' (selected) and 'Auto CQM'. Below this, the text 'Enter CQM Resistance Below' is displayed. A large blue box shows the number '120'. To the right of this box is a button labeled 'Open Circuit'. Below the '120' box, there is a checked checkbox followed by the text 'Allow user to modify CQM resistance during test'. At the bottom right, there is a button labeled 'Back to Step Edit'.

Auto CQM Step – Auto CQM steps allow for greater automation of the autosequence. Auto CQM steps can be configured as a single resistance test point or as an automatic sweep of CQM resistances where the CQM status is tested for normal or alarm conditions.

Manual CQM Auto CQM

Single Value Step Values List Values

Enter CQM Resistance Below

50

Open Circuit

Normal CQM Expected

Alarm CQM Expected

Auto Advance on Pass

Auto Start CQM Test

Back to Step Edit

Auto Advance on Pass – This setting allows for automatically stepping through the autosequence if the CQM status matches the expected setting.

Auto Start CQM Test– When this setting is enabled the ESU-2400 will automatically trigger the CQM state evaluation to determine if the step passes or fails. If this option is disabled, the operator will have to trigger the CQM test.

Single Value Tab - The single Value Auto CQM step (shown above) will apply a single resistance to the DUT CQM circuit and determine whether the step passes or fails based on the expected status.

Step Values Tab – This tab allows the user to configure a series of CQM resistances to be stepped through. The CQM resistance can be configured to step by a fixed resistance amount or by a fixed number of steps across a range or resistances. At each step, the DUT CQM state is evaluated. The test can be configured to stop when either an alarm or normal CQM state occurs.

Manual CQM Auto CQM

Single Value **Step Values** List Values

First Load Ohms

Last Load Ohms

Step Loads By Ohms

Total Steps in Test

Stop when CQM is normal

Stop when CQM alarm occurs

Auto Advance on Pass

Auto Start CQM Test

The Set Tolerance button is used to determine the pass / fail parameters. The CQM resistance will be stepped until the CQM state is either normal or alarm as programmed in the step. This point is called the trip resistance. The tolerance configuration allows the user to configure the trip points that result in a pass or fail status for the test.

Manual CQM Auto CQM

Single Value **Step Values** List Values

Setup CQM Validation Requirements

CQM Trip Point Ohms

Trip Upper Limit Ohms

Trip Lower Limit Ohms

Auto Advance on Pass

Auto Start CQM Test

List Values Tab – This allows the user to configure a list of CQM resistances that are used in the test. During the test the CQM resistance will be sequentially set to the values shown in the CQM resistance list. The step can be configured to stop when the CQM state is either alarm or normal.

The screenshot shows the 'List Values' tab of a software interface. At the top, there are radio buttons for 'Manual CQM' (unselected) and 'Auto CQM' (selected). Below this are three tabs: 'Single Value', 'Step Values', and 'List Values' (which is active). The 'List Filename' is set to 'Default'. A central list box contains the values 120, 125, 128, and 130, with up and down arrow buttons on the right. To the left of the list are buttons for 'Open List', 'Save List', and 'Clear List'. To the right are buttons for 'Add Load' and 'Delete Load'. Below the list, there are two radio buttons: 'Stop when CQM is normal' (unselected) and 'Stop when CQM alarm occurs' (selected). There are also checkboxes for 'Auto Advance on Pass' (unselected) and 'Auto Start CQM Test' (unselected). A 'Set Tolerance' button is located to the right of the second radio button. At the bottom right is a 'Back to Step Edit' button.

The Set Tolerance button is used to determine the pass / fail parameters. The CQM resistance will be stepped until the CQM state is either normal or alarm as programmed in the step. This point is called the trip resistance. The tolerance configuration allows the user to configure the trip points that result in a pass or fail status for the test.

The screenshot shows the 'Setup CQM Validation Requirements' dialog box. It has a title bar with 'Manual CQM' (unselected) and 'Auto CQM' (selected) radio buttons. Below the title bar are three tabs: 'Single Value', 'Step Values', and 'List Values' (which is active). The main area is titled 'Setup CQM Validation Requirements'. It contains three rows of configuration: 'CQM Trip Point' with a value of 135 and unit 'Ohms'; 'Trip Upper Limit' with a value of 140 and unit 'Ohms'; and 'Trip Lower Limit' with a value of 130 and unit 'Ohms'. Each value is entered in a blue button-like field. To the right of the 'Trip Lower Limit' field is an 'OK' button. At the bottom left, there are two checkboxes: 'Auto Advance on Pass' (unselected) and 'Auto Start CQM Test' (unselected). At the bottom right is a 'Back to Step Edit' button.

Running the Autosequence:

When an autosequence is started, the user is first prompted to enter information about the DUT. The data can be entered by pressing on one of the fields and entering the information from the onscreen keyboard, external keyboard, or barcode scanner.

**Please Enter the following information
for the test report.**

Generator ID:

Manufacturer:

Model:

Serial Number:

Tested By:

Signature:
(Tap to insert
signature)



Instruction Only Steps – These steps will display the instructions that the user is supposed to follow before proceeding to the next step. Once the instructions have been performed, the status must be updated to identify if the step passed or failed. Notes can be added by pressing the paperclip icon at the bottom of the screen.

Autosequence Step 1/7 Operator Instruction

Check Front Panel

Inspect rear panel for any damaged connectors or pins.

Ensure that a footswitch can be plugged into the rear connectors and that the dut responds to the footswitch input.

Abort

Show Meter
 Show Text



Pass
 Fail



RF Energy / Leakage steps – These steps will begin by showing the operator the step title and instructions. After the instructions are read, pressing the Show Meter button will allow the operator to perform the measurement. If the step is setup for the operator to trigger the DUT, the operator must activate the DUT and then press Capture to analyze the measurement and validate the step. If the step is setup to automatically trigger the generator, the operator simply presses the Capture button and the DUT will automatically be activated and the measurement analyzed.

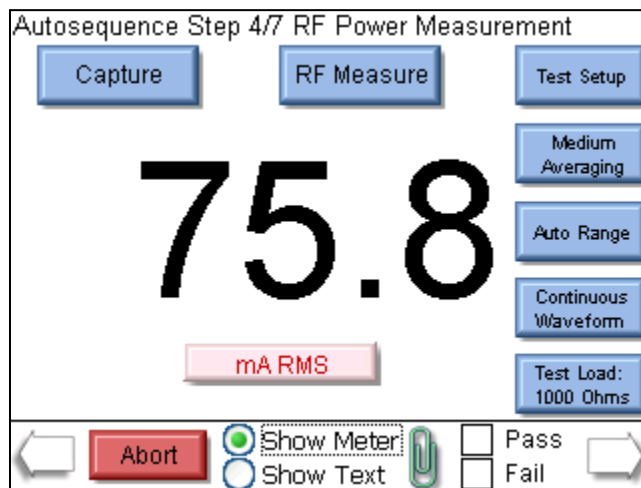

The step can be re-run by pressing the New Capture button after a reading has been taken.

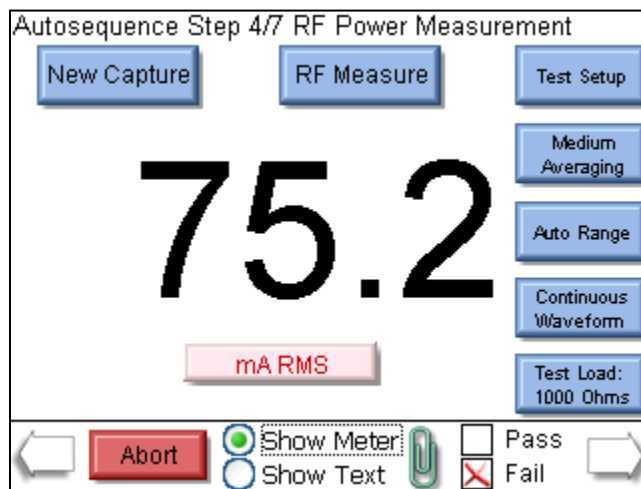

Load Curve Steps – This step will begin by showing the operator the step title and instructions. After the instructions are read, pressing the Show Meter button will allow the operator to perform the load curve.

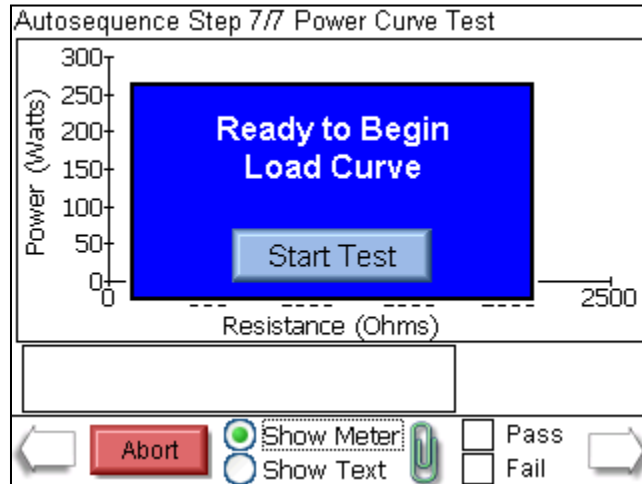

At the end of the load curve, the operator can view the measurements or rerun the load curve. The operator must manually validate the test by pressing the Pass or Fail box.

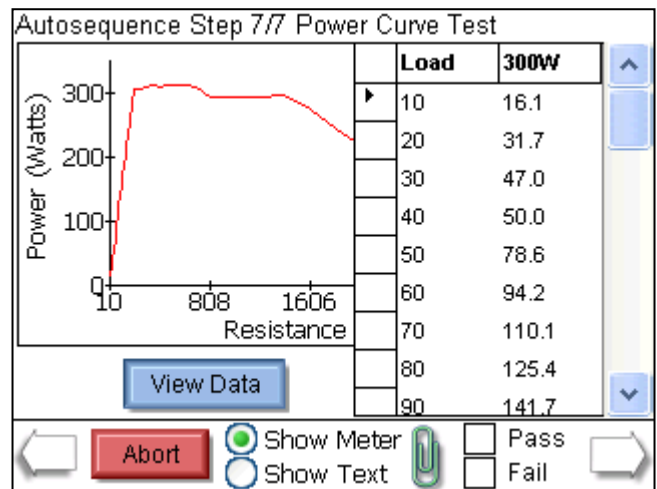
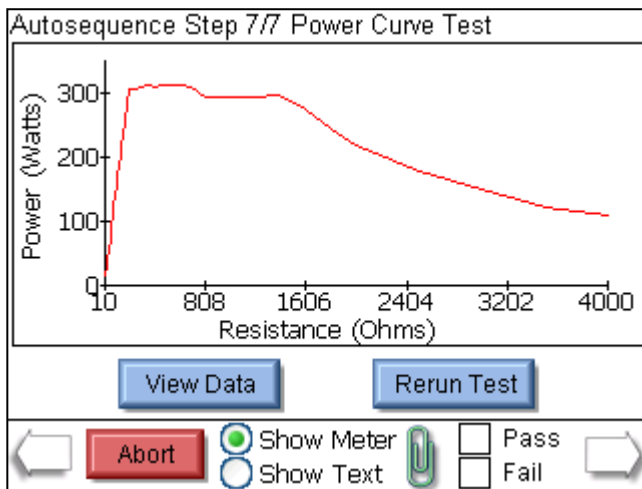

Manual CQM Step – This step shows both the instructions and the step configuration. If the step has been configured to allow the user to adjust the CQM resistance, the following screen will be shown. The user must manually determine the pass or fail status of this step.

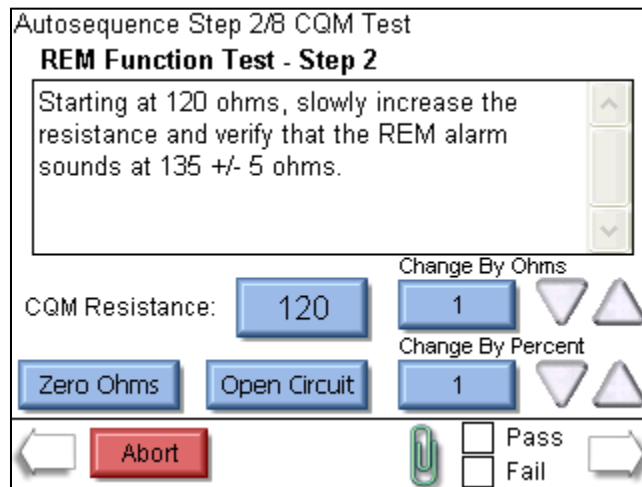

Auto CQM Step – The automated CQM step also shows the instructions to the user as well as the CQM resistance. When the Run Auto CQM step button is pressed, the CQM status of the DUT is evaluated to determine whether the step passes or fails.

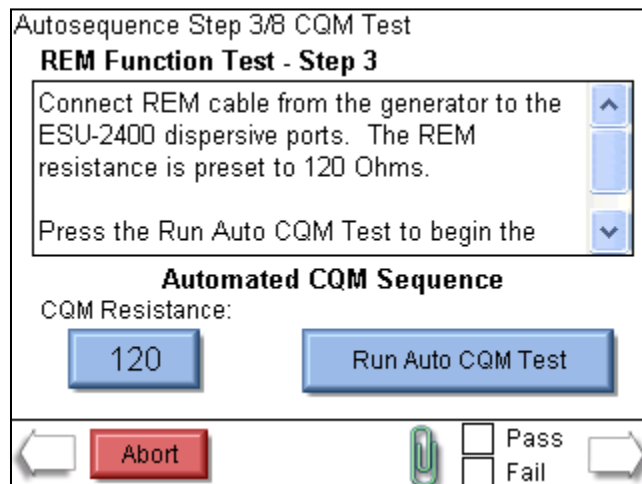

Autosequence Results – After all of the steps have been completed, the result screen will be shown. This screen indicates whether the test passed or failed.

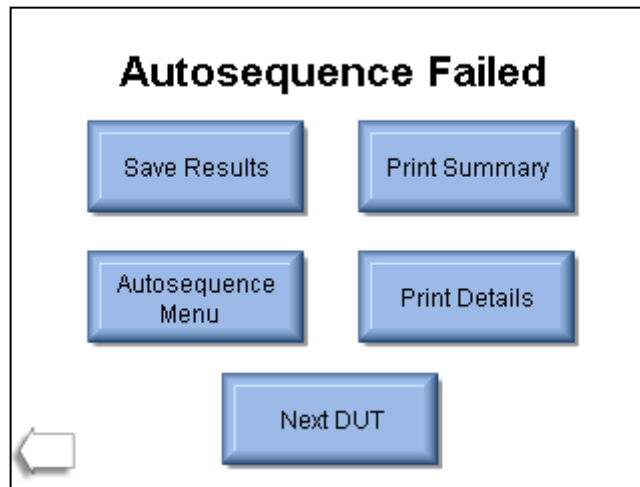

Save Results – This button allows the user to save the autosequence results to a file.

Print Summary – This button allows the user to print only the test header and test summary sections.

Print Details – This button allows the user to print the test header, test summary, and details of each autosequence step.

Autosequence Menu – This button returns the user to the main autosequence menu.

Next DUT – This initiates a new autosequence and returns the user to the DUT information screen.

Back Arrow – This takes the user back a step, allowing the full test to be reviewed.

MEASURE RF ENERGY

This screen configures the ESU-2400 to measure the RF output of an Electrosurgical Generator. From this screen the user can configure the measurement, the test load, the parameters on the screen, and even trigger the DUT.

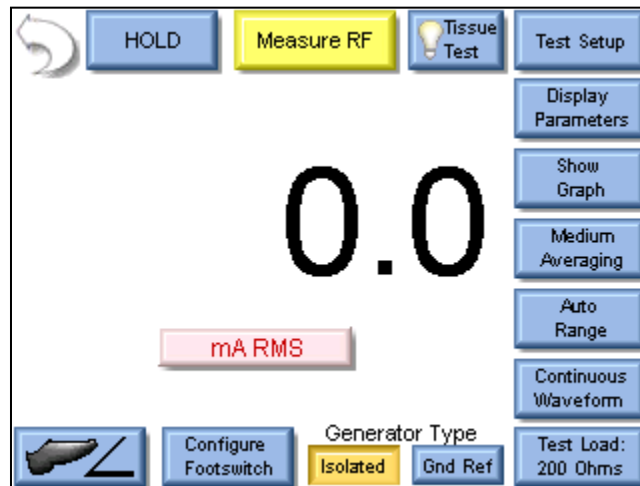

The measurement mode can be configured using the keys around the top and right side of the screen. The buttons are described below in a clockwise sequence starting with the back arrow.

Back Arrow – Pressing the back arrow takes the user to the Main Screen.

Hold Key – The Hold key toggles the Hold mode. Measurements are not updated while in the Hold mode.

Measure RF – This button allows the user to select whether the DUT being tested has an isolated output or ground referenced output. Some generators such as Hyfrecators do not have a return pad and rely on earth ground as the current return path. When testing these generators, select Ground Referenced Output and the ESU-2400 will configure the variable load to measure current from the active input to earth ground.

Tissue Test – This button is used to initiate the Tissue Test mode. This mode evaluates the tissue response function of the DUT. In this mode, the ESU-2400 is configured for an external TRL-2420 lamp load. The ESU-2400 is connected in series with the load as shown below.

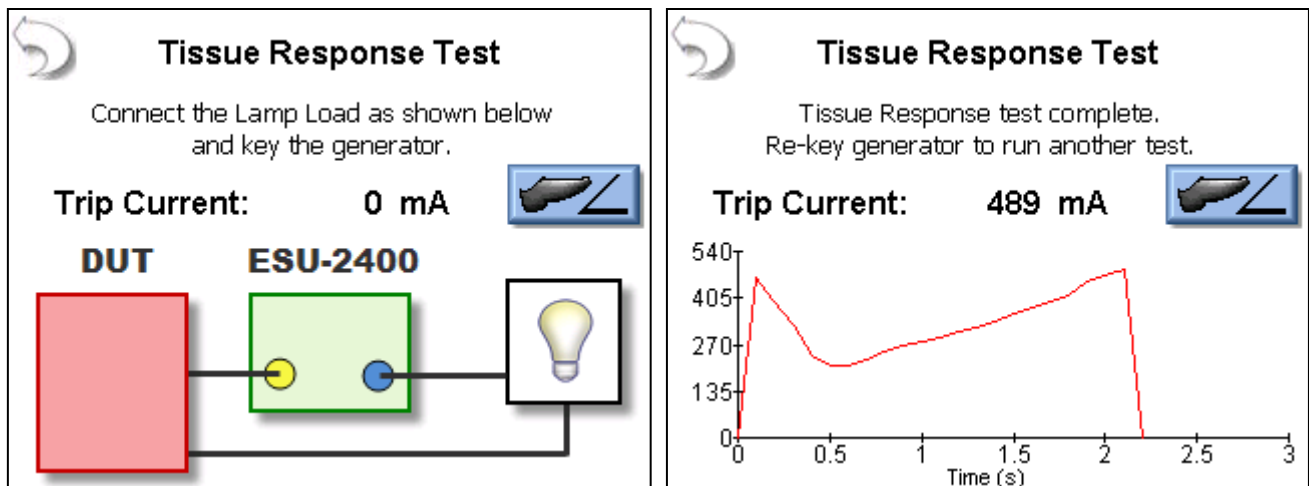

The Tissue Response Test will monitor the current in the load as the lamp heats up. When the current reaches the Tissue Response Trip point in the DUT, the generator output will automatically deactivate. At this point, the display will change to show the trip current as well as a graph of the current during the test. See page 11 for typical connections.

Test Setup – This button shows the connection diagram for the RF Measurement mode.

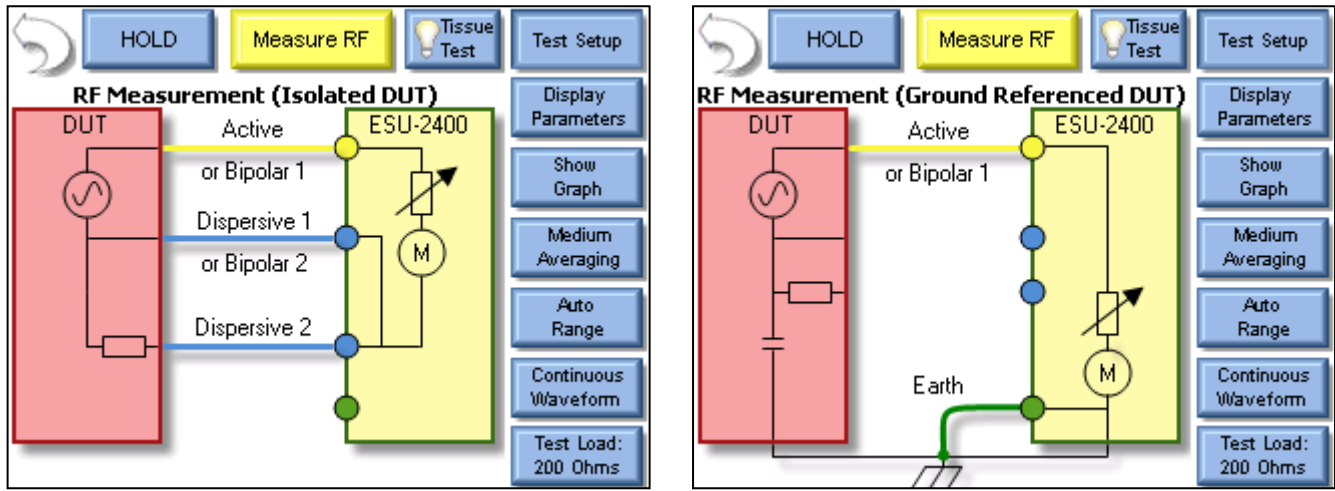

Display Parameters – This key allows the user to select the number of measurements, or zones, that are shown on the screen. 6 Screen configurations are available, 5 Display Screens which have 1, 2, 3, 4 and 5 display zones respectively, and a Measurement List Screen which shows all available measurements. Each Display Zone can be customized to show the desired parameter from the following options:

Mode	Parameter	Abbreviation	Description
Pulsed and Continuous Mode	mV RMS	mV	This is the mV measured directly from the RF current transformer.
	mA RMS	mA	This is the converted mA measurement based on the RF transformer mV to mA attenuation ratio.
	Power in Watts	Watts	This is the computed power based on load setting and mA measured.
	mV Peak	mV Pk	This is the maximum mV measured in the buffer. NOTE: This is shown as an absolute value.
	mV Peak - to - Peak	mV P-P	This is the difference between maximum mV measured and min mV measured.
	mV Peak / Peak - to - Peak	PK/P-P	This is the ratio of Peak versus Peak to Peak millivolts.
	mV Positive Peak Only	mV Pk+	This is the maximum positive mV measured in the buffer. For asymmetric waveforms this can determine if the output polarity is reversed.
	Crest Factor	CF	This is the ratio of peak to rms of the measured waveform.

Mode	Parameter	Abbreviation	Description
Pulsed Mode Only	Time - Pulse On	Ton	This is the duration that the pulsed waveform is on. (See Diagram 1)
	Time - Pulse Off	Toff	This is the duration that the pulsed waveform is off. (See Diagram 1)
	Time - Total Cycle	Tcyc	This is the total cycle time of the pulsed waveform (i.e. Ton + Toff). (See Diagram 1)
	% Duty Cycle	%Duty	This is the ratio of the pulse on time (Ton) versus cycle time (Tcyc). (See Diagram 1)
	mV Pulse	mV cyc	This represents the RMS mV over one pulsed cycle. (See Diagram 1)
	mA Pulse	mA cyc	This represents the RMS mA over one pulsed cycle. (See Diagram 1)
	Watts Pulse	Wcyc	This represents the RMS Watts over one pulsed cycle. (See Diagram 1)

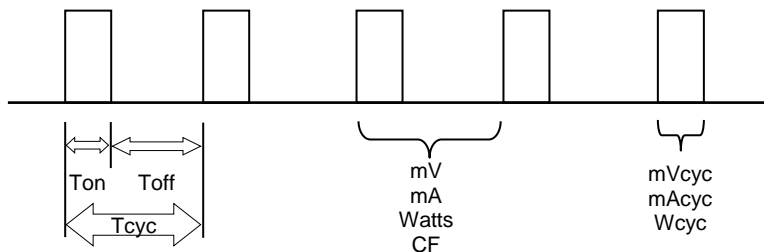
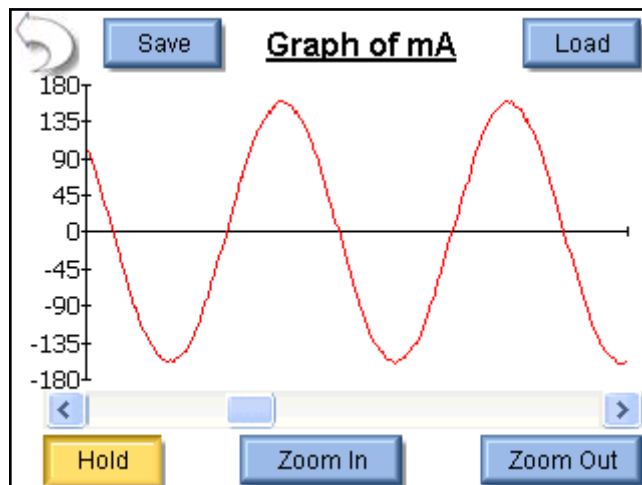

Diagram 1 (Pulsed mode only)

Show Graph –This key allows the user to display a graph of the latest RF measurement. Graphs can be saved and loaded from internal memory or external USB storage.



Show Graph Buttons –

Back Arrow – Returns to RF Measurement Screen

Save – Stores waveform to a comma delimited file. This file can then be imported into Microsoft® Excel.

Load – Opens previously saved waveform data.

Hold – Stops the waveform measurement update.

Zoom In – Expands the waveform to better view the individual data samples.

Zoom Out – Shows more waveform data to better view the overall waveform.

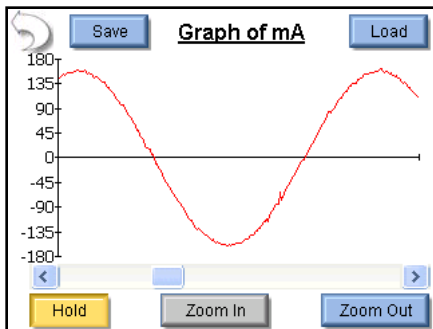

Full Zoom In

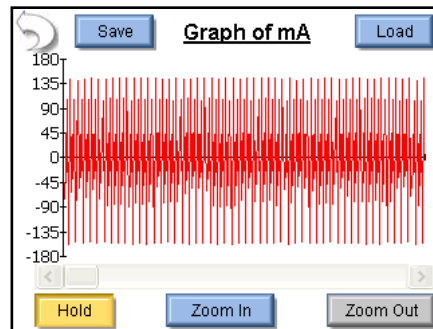

Full Zoom Out

Averaging – This key allows the user to select the FAST, MEDIUM, or SLOW averaging mode. Fast averaging will provide a quick response to incoming signals. Slow averaging will provide a more stable display, but will be slower to respond to small changes in the RF input signal. The value for the Averaging settings can be configured in the System Setup screen.

Input Range – Allows the user to select the range for the RF input. The range can be selected as 100mV, 1000mV, or Auto range.

Input Mode – Allows the user to select the mode for the RF measurement. The mode can be selected as Continuous or Pulsed. Continuous RF waveforms include Cut, Bipolar, or Coag modes. Pulsed RF waveforms consist of a long period duty cycle where the RF output might be active for 20 mS and inactive for 500 mS.

Test Load – This button shows a menu that allows the user to select internal load mode, external load mode, or the combination of internal/external loads. The menu also allows for the selection of the internal and external load values.

Load Values:		Load Mode:
200	Internal Load	<input checked="" type="radio"/> Internal
0	External Load	<input type="radio"/> External
200	Total Load	<input type="radio"/> Int\Ext

Generator Type – The buttons labeled “Isolated” and “Gnd Ref” allow the user to select whether the DUT being tested has an isolated output or ground referenced output. Some generators such as Hyfrecators do not have a return pad and rely on earth ground as the current return path. When testing these generators, select Gnd Ref and the ESU-2400 will configure the variable load to measure current from the active input to earth ground.

Configure Footswitch – This button opens the footswitch configuration menu that will select the footswitch output and duration that is used when the footswitch trigger button is pressed. To close the footswitch setup menu, press the Configure Footswitch button.

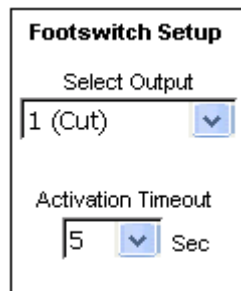

The image shows a dialog box titled "Footswitch Setup". It contains two configuration options, each with a dropdown menu. The first option is "Select Output", which is currently set to "1 (Cut)". The second option is "Activation Timeout", which is currently set to "5 Sec".

Field	Value
Select Output	1 (Cut)
Activation Timeout	5 Sec

Activate Footswitch – This button is used to trigger the footswitch output for the duration that is configured in the Footswitch Setup menu. The footswitch can be deactivated before the activation timeout period by pressing the Activate Footswitch button a second time. While the footswitch output is active, the Activate Footswitch button will remain highlighted with a yellow background.

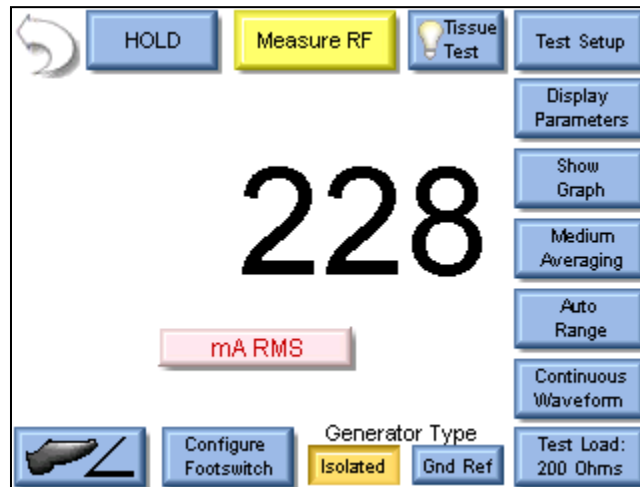

POWER LOAD CURVES

The power load curve allows the user to test and graph the power output of the DUT. The loads used and DUT power settings are programmable. The ESU-2400 can be configured to trigger the DUT using one of the five footswitch relay outputs. For further automation, the RS-232 port can be used to configure the DUT output mode and power level during the Load Curve.

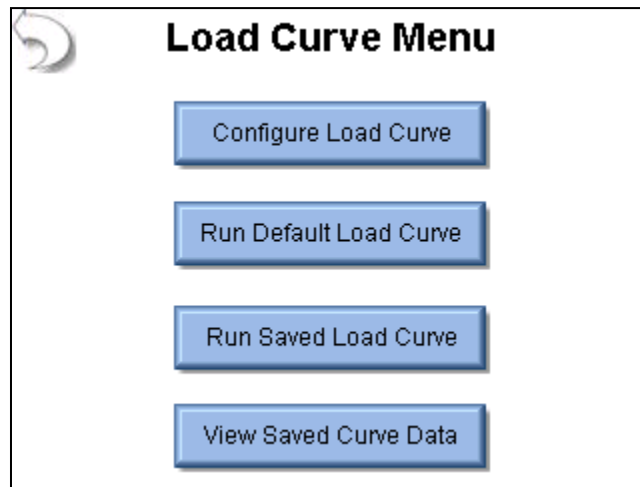

The load curve menu allows the user to configure a load curve, run the factory default load curve, run a saved load curve profile, or view a load curve that was saved previously.

Load Curve Configuration

The screenshot shows a software interface for configuring load curves. At the top, there are four tabs: 'Setup Loads' (selected), 'Setup Power', 'Meter', and 'DUT'. Below the tabs, there are two radio buttons: 'Step Based Loads' (selected) and 'List Based Loads'. Under 'Step Based Loads', there are three input fields: 'First Load' with a value of 50 Ohms, 'Last Load' with a value of 750 Ohms, and 'Step Loads By' with a value of 50 Ohms. Below these, there is another radio button 'Step Loads By' (unselected) and a 'Total Steps in Test' field with a value of 20. At the bottom of the dialog, there are two buttons: 'Save Configuration' and 'Start Load Curve'.

The tabs across the top of the screen allow the user to configure the Loads, Power, Meter and ESU generator.

Load Config Tab – The loads can be configured as either a step based load change or a list based load change. For the step based loads, the user enters the first load to be used and the last load to be used. Then the ESU-2400 steps the loads by either a fixed resistance or by a calculated amount to achieve a fixed number of steps for the test. In the picture above, the load curve would start at 50 ohms, and increment the load by 35

ohms $\left(\frac{750-50}{20}\right)$ to provide 20 total steps in the test.

For list based loads, the following screen is shown, allowing the user to select specific resistances to be used for the test.

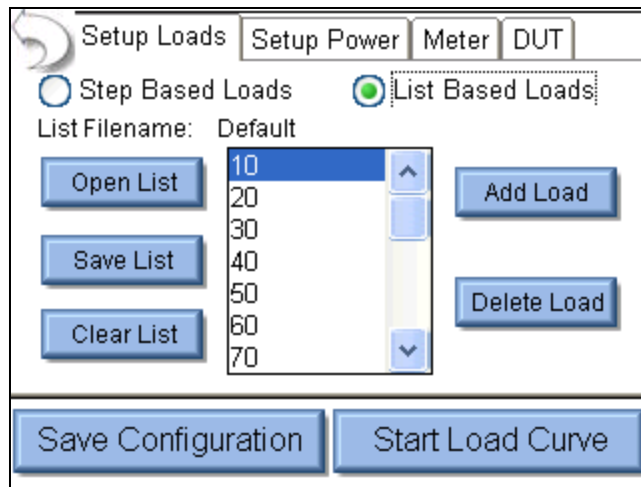

Single Power Level Tab – For the load curve power configuration, the user can set the ESU-2400 to run the load curve at a single power level or multiple power levels. The following screen shows the configuration for a single power level.

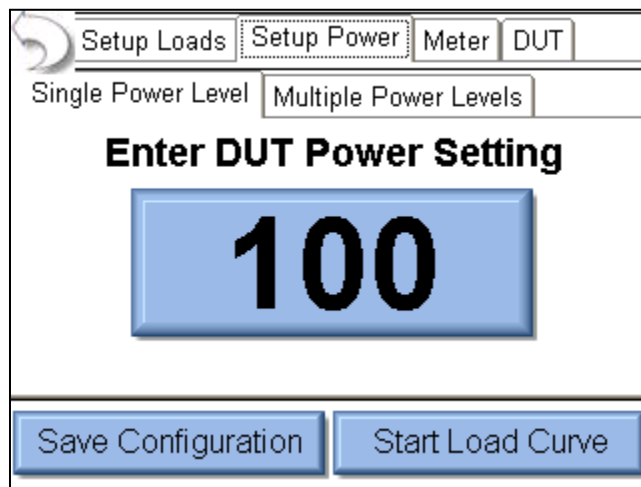

By pressing on the power setting, the user will be able to enter the desired power level for the load curve test.

Multiple Power Levels Tab – When using multiple power levels, the configuration options are similar to the Load config. The user can select either step based power levels based on a fixed change in watts or based on the number of desired steps in the test.

The screenshot shows a software interface with a tabbed menu at the top containing 'Setup Loads', 'Setup Power', 'Meter', and 'DUT'. The 'Setup Power' tab is active, and within it, the 'Multiple Power Levels' sub-tab is selected. Two radio buttons are present: 'Step Based Power' (which is selected) and 'List Based Power'. Below these, there are four input fields: 'First Power' with a value of 50 Watts, 'Last Power' with a value of 300 Watts, 'Step Power By' with a value of 50 Watts, and 'Total Steps in Test' with a value of 5. At the bottom of the window are two large buttons: 'Save Configuration' and 'Start Load Curve'.

For list based power levels, the user can enter any combination of power settings to use for the load curve, as shown below.

The screenshot shows the same software interface as above, but with the 'List Based Power' radio button selected. The 'Step Based Power' radio button is unselected. Below the radio buttons, there are three buttons: 'Open List', 'Save List', and 'Clear List'. To the right of these buttons is a text field labeled 'Filename: Default'. Below the text field is a list box containing the values 50, 100, 150, 250, and 300. To the right of the list box are two buttons: 'Add Power' and 'Delete Power'. At the bottom of the window are the same two large buttons: 'Save Configuration' and 'Start Load Curve'.

Meter Setup Tab – This screen allows for the selection of the input range, input mode, and averaging rate. These settings are adjustable to match the waveform or device being tested.

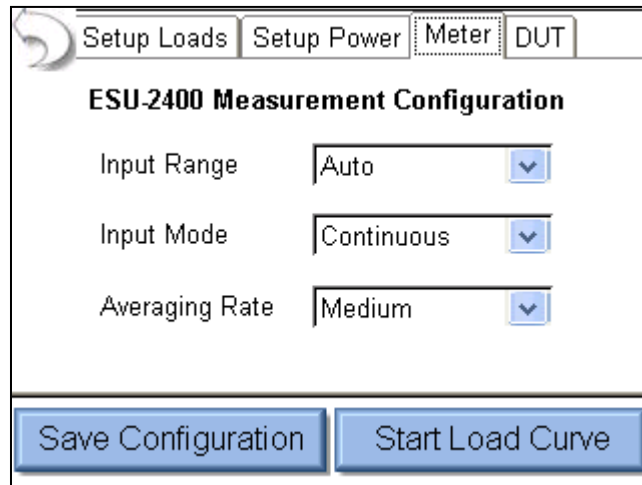

For more information on measurement modes, refer to the RF Measurement chapter of the manual on page 72.

DUT-Setup – The DUT can be triggered by the Operator or the ESU-2400, as shown below. When Operator is selected, the user will be prompted when to activate or deactivate the ESU.

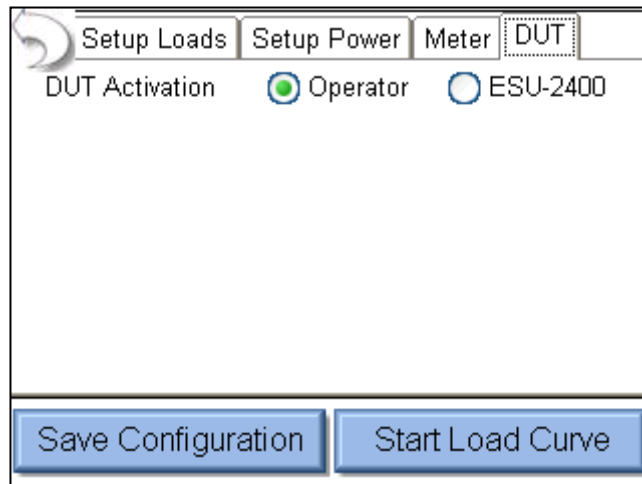

When ESU-2400 is selected as the trigger source, the activation can be setup manually or by DUT manufacturer and model. For Manual Setup, the user selects the desired footswitch output to be used. If RS-232 is enabled, the user also selects the baud rate and enters commands to be used for DUT setup and control. When entering commands use “%P” to represent the power level. In the example below, ESU-2400 would send the command “:FTP300” when setting the power level to 300 watts.

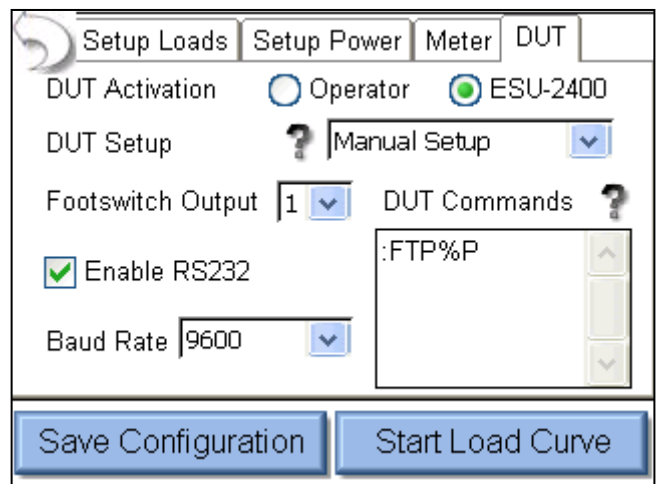
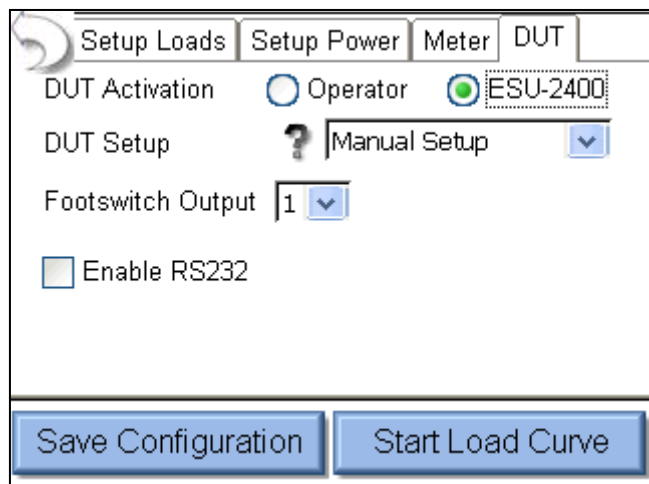

When the DUT Setup is set to Setup by Model, the user selects the DUT manufacturer and model as well as the desired output mode. The ESU-2400 handles all of the RS-232 and footswitch output setup.

As the load curve runs, the screen will be updated with the measured power from the DUT. At the end of the load curve, there will be buttons available to save the load curve results or view the individual data points.

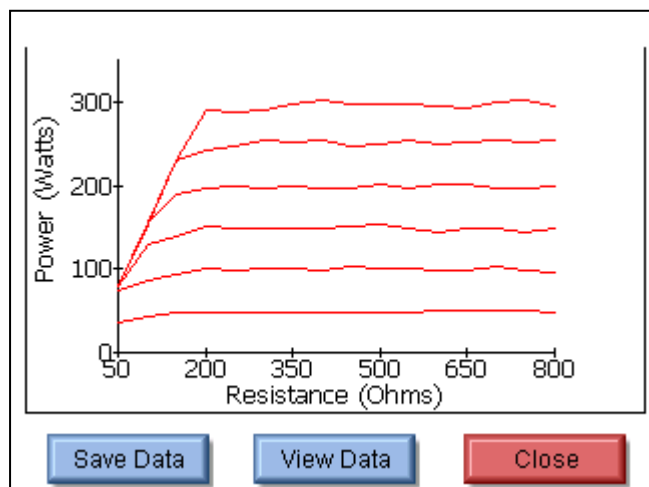

File	Load	50W	100W	150W	200W
	50	36.5	75.1	78.3	78.3
	100	42.9	86.9	128.9	155.5
	150	48.2	94.4	139.9	188.4
	200	47.7	99.6	150.0	196.2
	250	49.0	99.1	149.4	197.9
	300	48.0	100.5	149.1	195.5
	350	47.4	99.8	149.8	198.8
	400	49.1	98.7	148.7	196.6

REM/ARM/CQM

The REM/ARM/CQM key from the main menu will access the Return Electrode Control Quality Monitor Test. This menu allows for the user to control the resistance between the blue CQM terminals on the front of the ESU-2400.

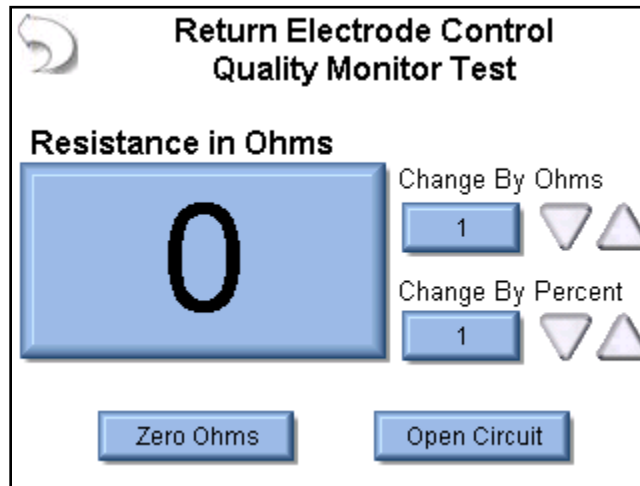

CQM Resistance – The CQM resistance can be entered directly by pressing on the resistance indicator button. The maximum CQM resistance is 500 ohms.

Change by Ohms – These buttons allow the user to adjust the CQM resistance up or down by a set number of ohms. The maximum step size is 500 ohms.

Change by Percent – These buttons allow the user to adjust the CQM resistance up or down by a percentage of the current resistance. Maximum percent change is 500%. The minimum resistance change is 1 ohm. That is, if the current resistance is 1 ohm and the % change is 1%, pressing the Up / Down buttons will still change the resistance by 1 ohm.

Zero Ohms – This button will set the CQM resistance to zero ohms.

Open Circuit – This button will toggle the CQM resistance to an open circuit.

MEASURE RF LEAKAGE

The RF Leakage screen allows the user to take RF leakage measurements. The measurement mode can be configured using the keys around the top and right side of the screen.

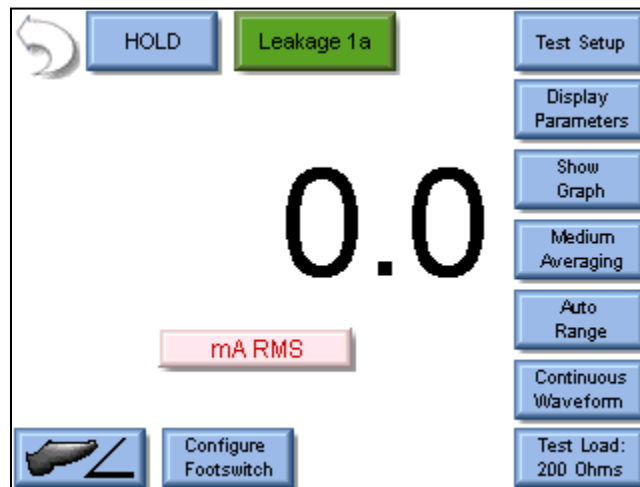

The buttons on this screen are described below in a clockwise sequence starting with the back arrow.

Back Arrow – Pressing the back arrow takes the user to the Main Screen.

Hold Key – The Hold key toggles the Hold mode. Measurements are not updated while in the Hold mode.

Leakage Mode – This button allows the user to select which measurement mode is to be used. There are four leakage measurement modes available.

Leakage 1a – This leakage test, specified by the IEC as Active Electrode to Ground, is for testing the RF leakage to earth ground of an Isolated Output type CF electrosurgical generator from a single active or dispersive lead. The test complies with IEC 601.2.2, sec. 19.101b, fig, 104 and sec. 19.102, adopted by ANSI/AAMI HF18-2001. The purpose of this test is to verify that open circuit RF leakage of the Device Under Test (DUT) meets or exceeds the IEC specification. The ESU-2400 internally connects the load to earth ground. An external ground is also provided at the front panel.

NOTE: DO NOT TEST AN EARTH REFERENCED TYPE BF ELECTROSURGICAL GENERATOR WITH THIS TEST, THE RESULTING MEASUREMENT WILL BE ERRONEOUS.

WARNING – ONE LEAD AT A TIME
Only test one lead of the ESU Generator at a time, either Active or Dispersive, not both.

Leakage 1b – This leakage test, specified by the IEC as Dispersive Electrode to Ground, is for testing the RF leakage to earth ground of an Isolated Output type CF electro-surgical generator from a single active or dispersive lead. The test complies with IEC 601.2.2, sec. 19.101b, fig, 104 and sec. 19.102, adopted by ANSI/AAMI HF18-2001. The purpose of this test is to verify that open circuit RF leakage of the Device Under Test (DUT) meets or exceeds the IEC specification. The ESU-2400 internally connects the load to earth ground. An external ground is also provided at the front panel.

NOTE: DO NOT TEST AN EARTH REFERENCED TYPE BF ELECTROSURGICAL GENERATOR WITH THIS TEST, THE RESULTING MEASUREMENT WILL BE ERRONEOUS.

WARNING – ONE LEAD AT A TIME
Only test one lead of the ESU Generator at a time, either Active or Dispersive, not both.

Leakage 2 – This leakage test, specified by the IEC as Earth Reference Leakage Type BF (Load Between Electrodes), is for testing the leakage to earth ground of a Ground Referenced Output type BF electro-surgical generator from the active output. This test complies with IEC 601.2.2, sec. 19.101a, test 1, fig. 102, and sec. 19.102, adopted by ANSI/AAMI HF18-2001. The purpose of this test is to verify that the RF leakage of the Device Under Test (DUT) meets or exceeds the IEC specification.

Leakage 3 – This leakage test, specified by the IEC as Earth Reference Leakage Type BF (Load from Active Electrode to Earth) is for testing the leakage to earth ground of a Ground Referenced Output type BF electrosurgical generator from the active output. This test complies with IEC 601.2.2, sec. 19.101a, test 2, fig. 102, and sec. 19.102, adopted by ANSI/AAMI HF18-2001. The purpose of this test is to verify that the RF leakage of the Device Under Test (DUT) meets or exceeds the IEC specification.

Test Setup – This key shows a picture of the connections for the current mode.

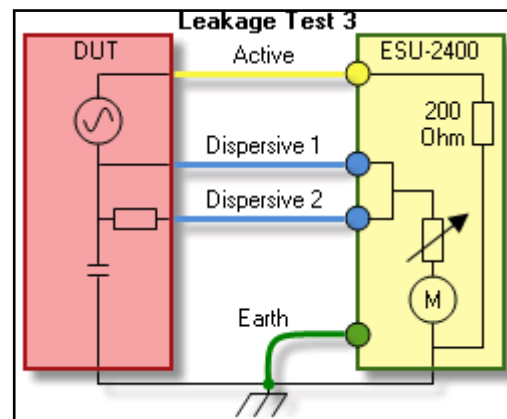
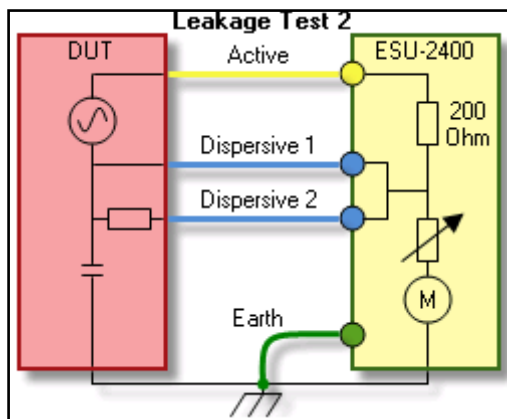
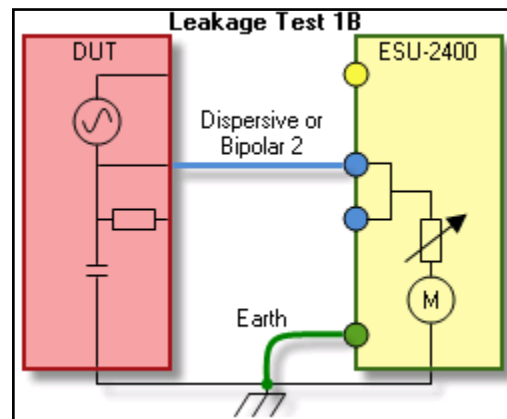
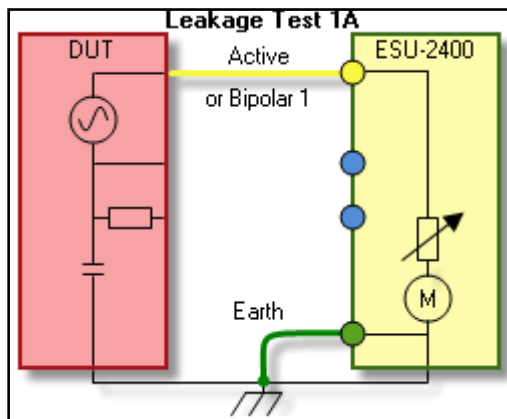

Display Parameters – This key allows the user to select the number of measurements, or zones, that are shown on the screen. 6 Screen configurations are available, 5 Display Screens which have 1, 2, 3, 4 and 5 display zones respectively, and a Measurement List Screen which shows all available measurements. Each Display Zone can be customized to show the desired parameter from the following options:

Mode	Parameter	Abbreviation	Description
Pulsed Mode Only	Time - Pulse - On	Ton	This is the duration that the pulsed waveform is on. (See Diagram 1)
	Time - Pulse Off	Toff	This is the duration that the pulsed waveform is off. (See Diagram 1)
	Time - Total Cycle	Tcyc	This is the total cycle time of the pulsed waveform (i.e. Ton + Toff). (See Diagram 1)
	% Duty Cycle	%Duty	This is the ratio of the pulse on time (Ton) versus cycle time (Tcyc). (See Diagram 1)
	mV Pulse	mV cyc	This represents the RMS mV over one pulsed cycle. (See Diagram 1)
	mA Pulse	mA cyc	This represents the RMS mA over one pulsed cycle. (See Diagram 1)
	Watts Pulse	Wcyc	This represents the RMS Watts over one pulsed cycle. (See Diagram 1)

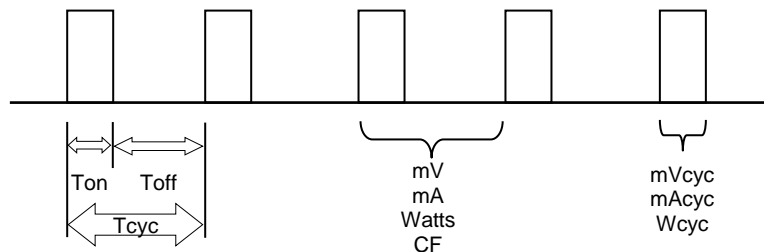

Diagram 2 (Pulsed mode only)

Show Graph – This key allows the user to display a graph of the latest RF measurement. Graphs can be saved and loaded from internal memory or external USB storage.

Averaging – This key allows the user to select the FAST, MEDIUM, or SLOW averaging mode. Fast averaging will provide a quick response to incoming signals. Slow averaging will provide a more stable display, but will be slower to respond to small changes in the RF input signal. The value for the Averaging settings can be configured in the System Setup screen.

Input Range – Allows the user to select the range for the RF input. The range can be selected as 100mV, 1000mV, or Auto range.

Input Mode – Allows the user to select the mode for the RF measurement. The mode can be selected as Continuous or Pulsed.

Test Load – This button shows a menu that allows the user to select internal load mode, external load mode, or the combination of internal/external loads. The menu also allows for the selection of the internal and external load values.

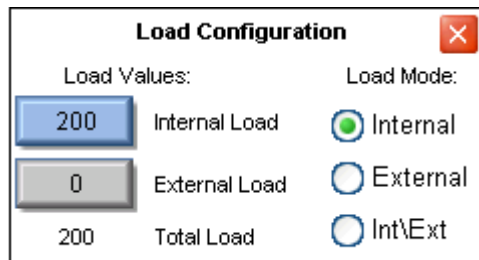

Configure Footswitch – This button opens the footswitch configuration menu that will select the footswitch output and duration that is used when the footswitch trigger button is pressed. To close the footswitch setup menu, press the Configure Footswitch button.

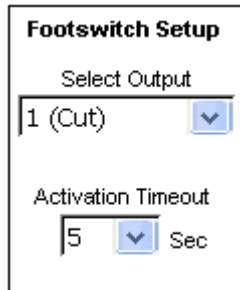

Activate Footswitch – This button is used to trigger the footswitch output for the duration that is configured in the Footswitch Setup menu. The footswitch can be deactivated before the activation timeout period by pressing the Activate Footswitch button a second time. While the footswitch output is active, the Activate Footswitch button will remain highlighted with a yellow background.



SYSTEM TOOLS

The tools screen allows the user to adjust system settings as well as update the ESU-2400 firmware or calibrate the touchscreen. There are two pages of system tools. The arrows at the bottom of the page navigate through the system setup pages. The round indicators at the bottom of the screen identify which page is currently viewed.

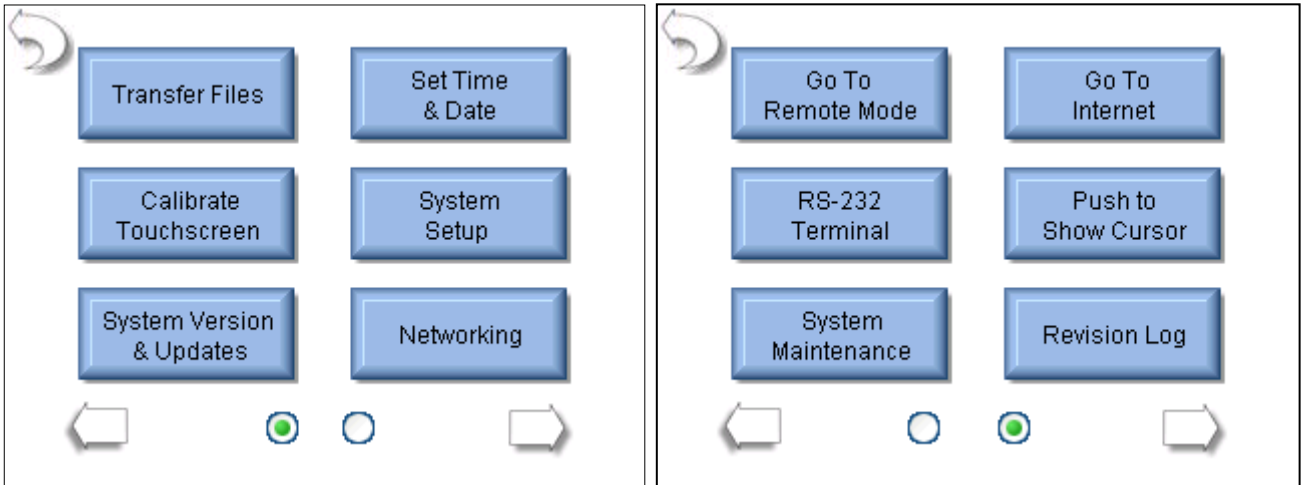

Transfer Files – This button allows the user to copy any folder or file (including pdf) between the ESU-2400 and an external USB flash drive, directly from the ESU-2400.

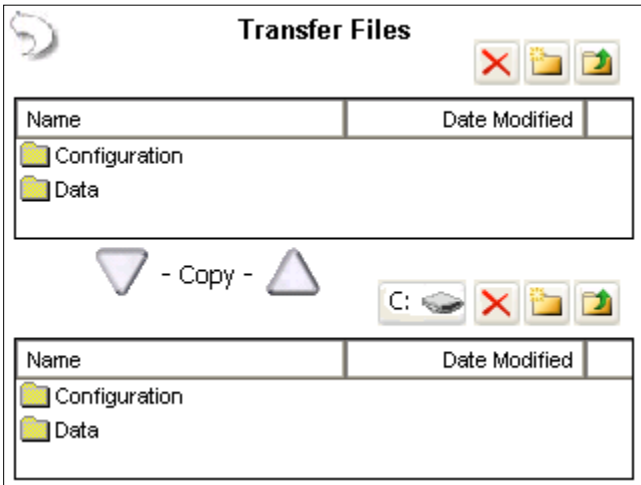

The top window is the ESU-2400 (C: drive). The bottom window allows the user to select the ESU-2400 (C: drive) or any available external USB flash drive (D:, E:, or F:) using the drive selection button. Highlight the folder or file to copy then press the copy arrow pointing towards the desired file location.

Set Time and Date – This button shows the Date and Time configuration screen. To change the Date or Time, press the appropriate button.

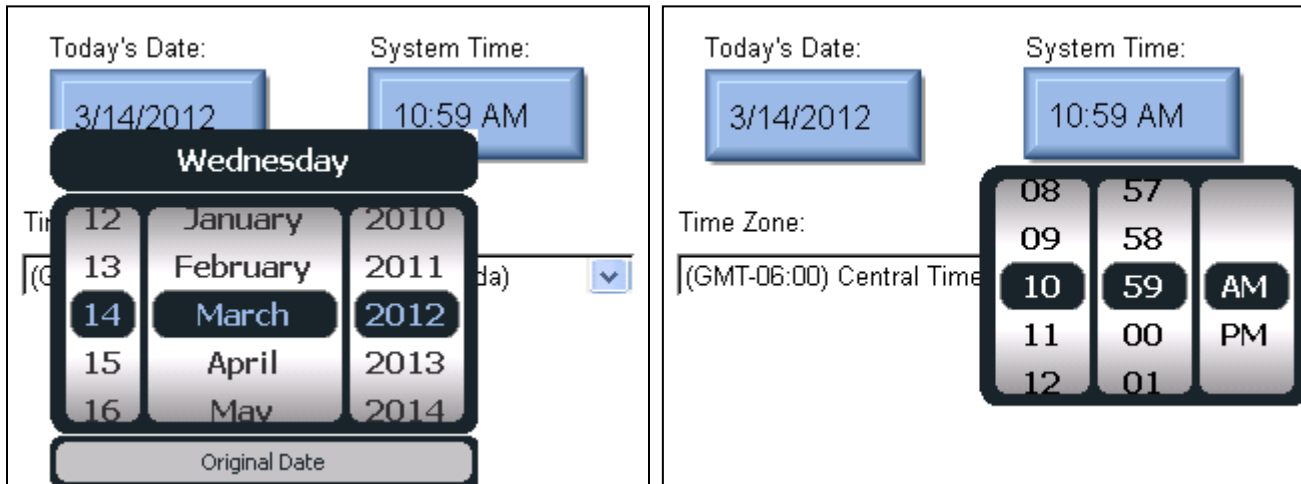

Then the Date/Time settings are set by scrolling the display to the desired value. Once the proper setting is shown, the Date/Time button is pressed again to accept the change.

Time Zone – This setting allows the user to localize the ESU-2400 to the user's time zone. **NOTE: When changing the Time Zone, the system must be rebooted before the change takes effect.**

Calibrate Touchscreen – This button allows the user to calibrate the touchscreen using a 4, 7, or 20 point calibration. Once calibration is started, follow the on – screen prompts to perform the calibration

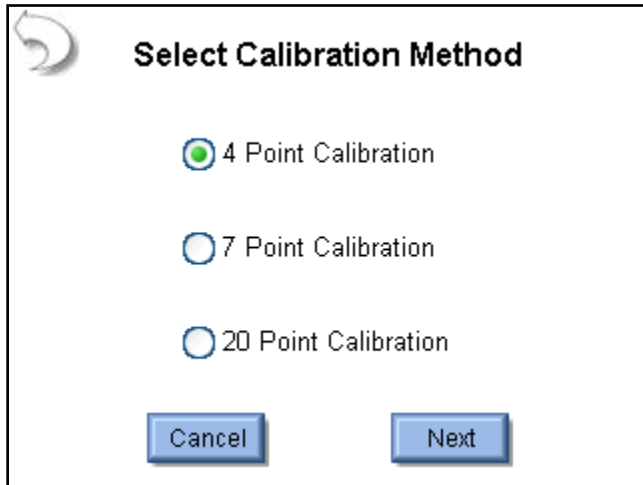

 **Select Calibration Method**

4 Point Calibration

7 Point Calibration

20 Point Calibration

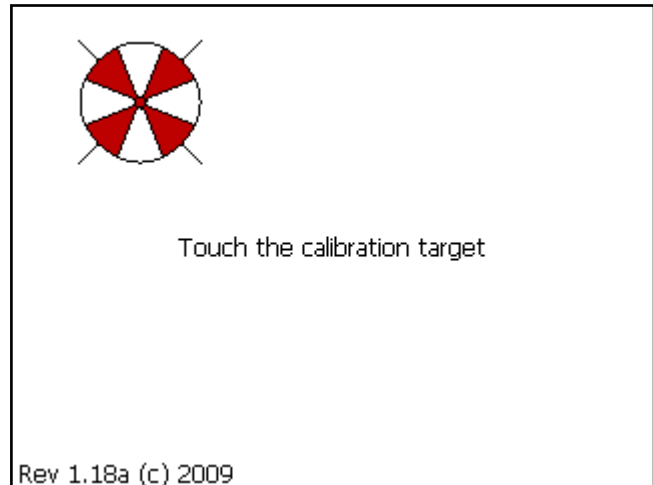

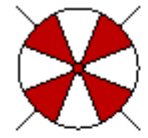

Touch the calibration target

Rev 1.18a (c) 2009

System Setup – This screen allows the user to configure the ESU-2400.

Display Averaging		System	
Slow	150 ?	Volume	7
Medium	15 ?	Startup Screen	Main
Fast	4 ?	Serial Number	1011
Filter Span	20.0 ?		

System Profiles	
Current Profile:	Default Profile Save Profile
Default	Load Profile

Display Averaging – The Display averaging settings of Slow, Medium, and Fast are programmed here. These determine the number of samples used in averaging the RMS measurements. The larger the number, the more stable the reading, but the less sensitive the system will be to small changes in readings. The filter span determines the maximum change in input readings that will be averaged.

Volume – This sets the volume for the ESU-2400.

Startup Screen – This selects the screen that is loaded as the ESU-2400 powers up.

Serial Number – This is a read only display of the ESU-2400 serial number.

Profiles – Profiles are used to save the measurement configuration, averaging settings, volume, and startup screen. If the user wants to change how the ESU-2400 powers up, the settings can be modified and then saved to a profile. The profile will be loaded on system startup.

System Version and Updates – This screen shows the revision of all of the software running on the ESU-2400 and allows the user to update the system to new versions or restore previous versions.

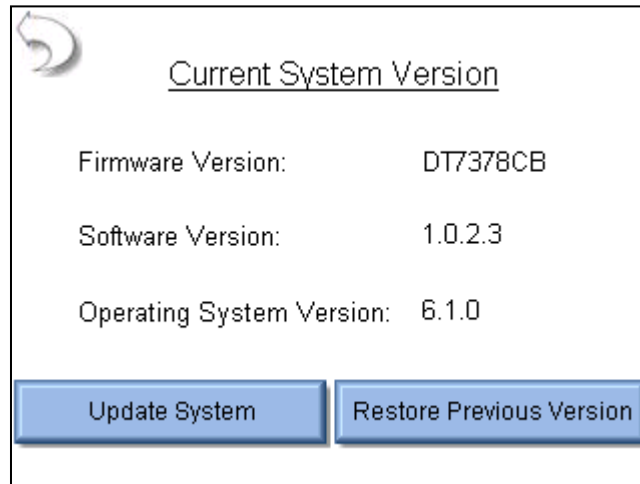

Update System – This button allows the user to update the ESU-2400 through the internet (FTP site) or with a USB Flash drive.

FTP Update:

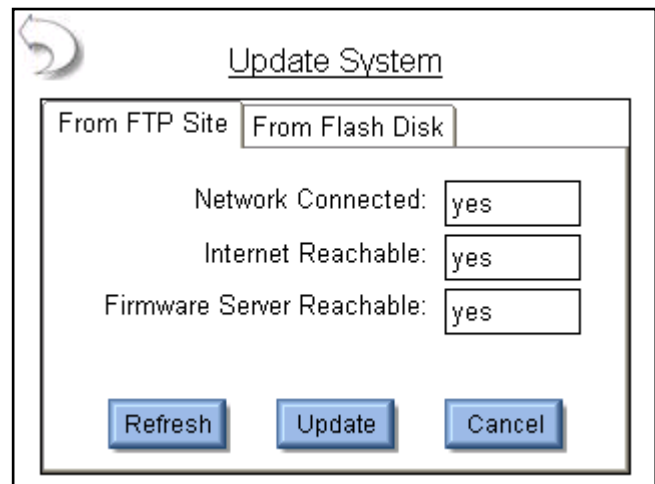
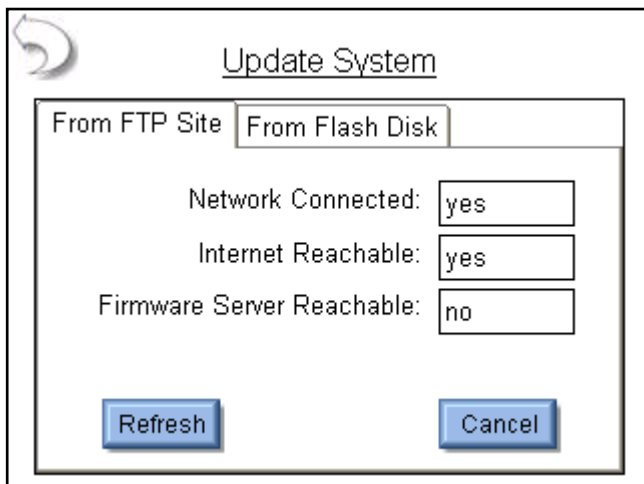

The system will default to updating from the internet and will indicate to the user whether the FTP site is reachable. If it is, an Update button will appear at the bottom of the screen.

When the Update button is pressed, the ESU-2400 will connect to the FTP server and check for available updates to the system.

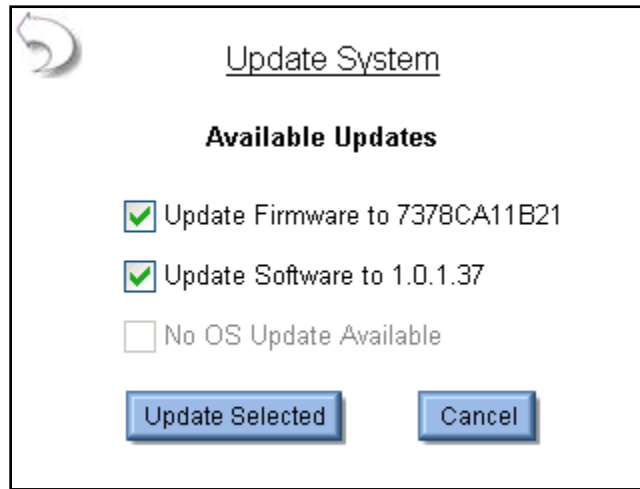

The user can perform all updates at once or select the software to update by using the check boxes. Once the desired updates are selected, the Update Selected button is pressed. The ESU-2400 will automatically download and install the updates to the system. When updating the Software or OS, the ESU-2400 will need to be rebooted.

The process for updating the system is to download the updated files, backup the existing software, install the new software, and reboot if necessary.

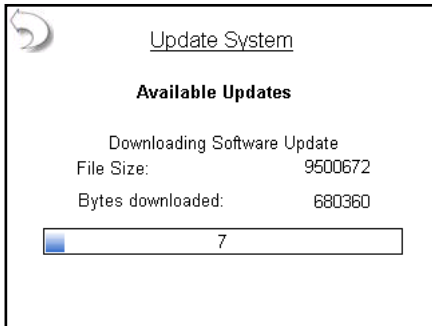

Downloading Updates

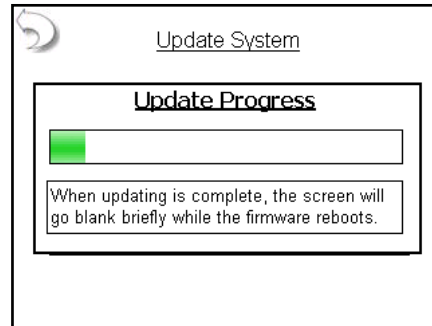

Updating Firmware

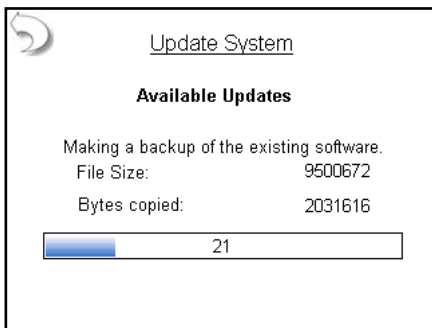

Backing Up Software

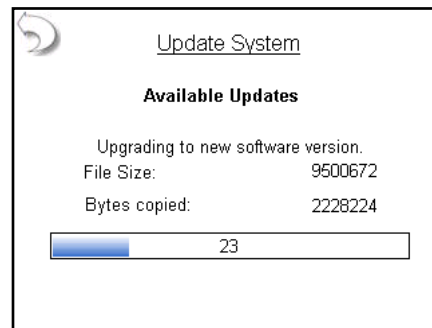

Installing Updates

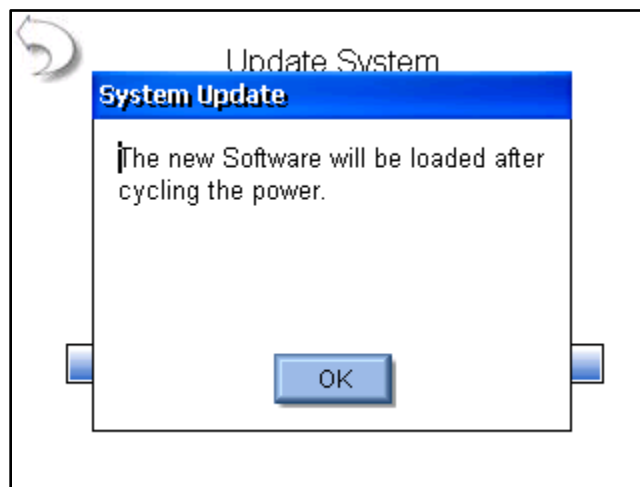

Update Complete

Update from Flash Disk – When updating from flash disk, the user must individually update the Firmware, Software, and Operating System. Firmware update files should begin with the filename DT7378 and have an extension of “.S19”. Software update files should begin with the filename “ESU-2400_”, end with the revision code and have an extension of “.exe”. Operating system files should begin with “NK_” and have an extension of “.bin”.

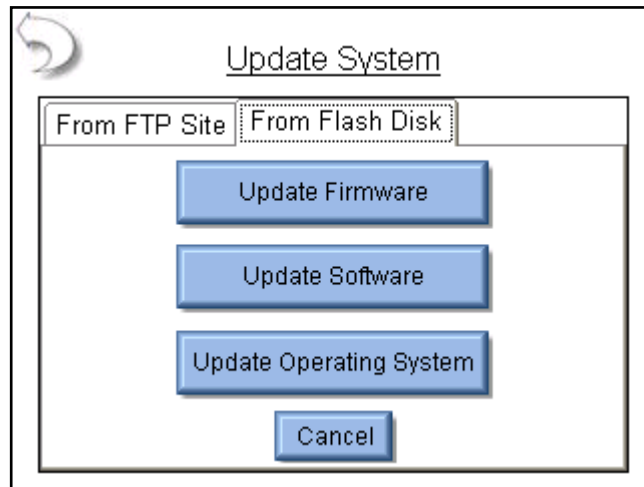

Restore Previous Versions – Each time the ESU-2400 is updated, it creates a backup of the previous version in case it is ever needed. The firmware, software, and operating system files are restored independently. To restore a previous version, first select the file from the backup log and then press the Restore button.

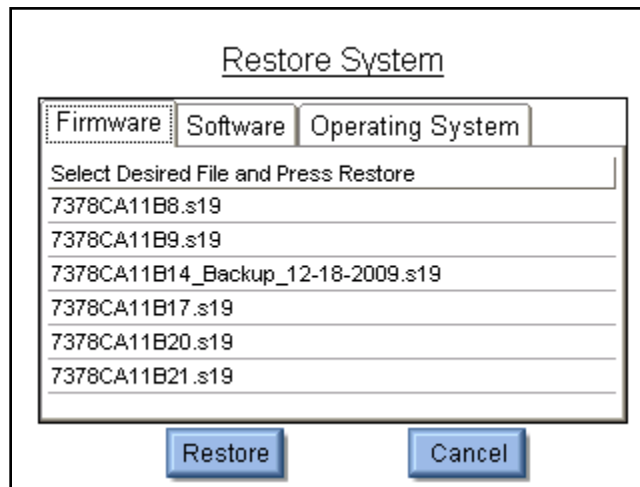

Networking – The networking screen shows the current network information and allows the user to select DHCP (automatic) or Static IP address mode.

TCP/IP Configuration	
Address Type:	DHCP
IP Address:	192.168.2.138
Subnet Mask:	255.255.255.0
Default Gateway:	192.168.2.1
MAC Address:	00:07:32:00:17:13
Network Name:	ESU2400_1011
OK Renew Dhcp Cancel	

Address Type – The user can select whether the IP address is received automatically from a DHCP server or configured for a Static IP address. **NOTE: After changing the Address Type, the system will need to be rebooted for the changes to take effect.**

IP Address – This field identifies the IP address when DHCP is enabled or allows the user to enter an IP address when the Static Address Type is selected.

Subnet Mask– This field identifies the Subnet Mask when DHCP is enabled or allows the user to enter a Subnet Mask when the Static Address Type is selected.

Default Gateway – This field identifies the Default Gateway when DHCP is enabled or allows the user to enter a Gateway address when the Static Address Type is selected.

MAC Address – This read only field identifies the MAC address of the ESU-2400.

Network Name – This identifies the ESU-2400 on the network. The default name is ESU2400_XXXX where “XXXX” is the ESU-2400 serial number. Network names must be unique for each device on a network. The network name is used when browsing the ESU-2400 on the network. For the example above, the ESU-2400 could be viewed in windows explorer by typing in \\ESU2400_1011 in the address field.

Remote Mode – This mode allows the ESU-2400 to be controlled from a remote PC on a network. To activate Remote mode, connect the ESU-2400 to the network. Then press the Go To Remote Mode button. The ESU-2400 can guide the operator through the process of setting up the remote mode connection. The CERHost utility mentioned in the procedure can be found on the ESU-2400 by browsing to the device on the network in windows explorer by typing \\ESU2400_xxxx\Utility in the address field where xxxx is the serial number of the ESU-2400.

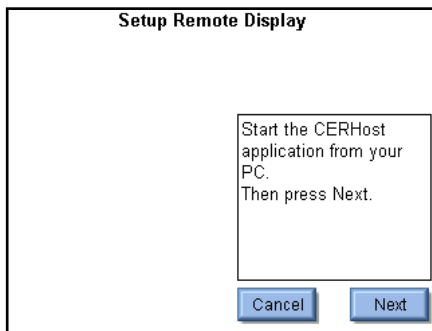
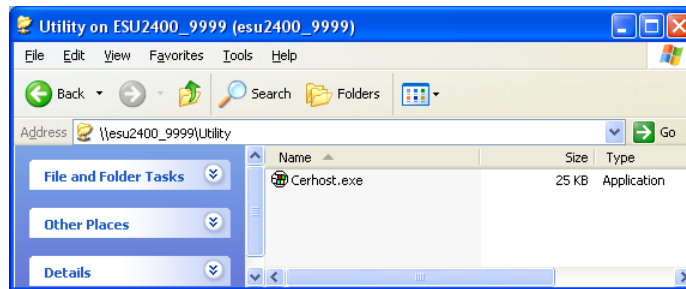

Step 1 - Start

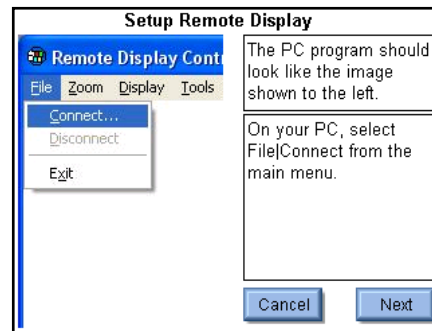

Step 2 - Start Connection

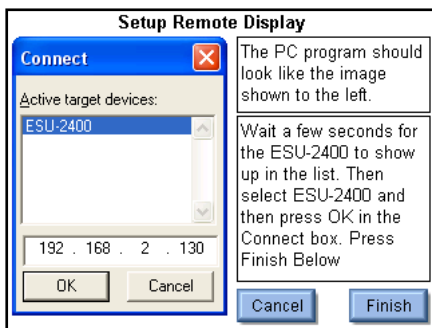

Step 3 - Connect to 2400

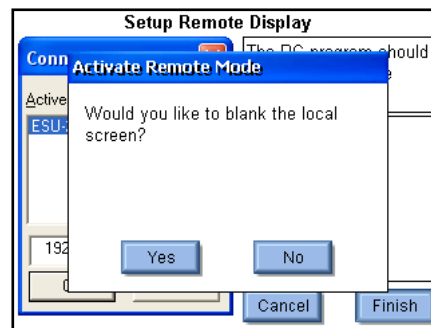

Step 4 - Blank 2400 screen

To return to local mode, press the Go To Local Mode button either in the remote PC display or on the ESU-2400.

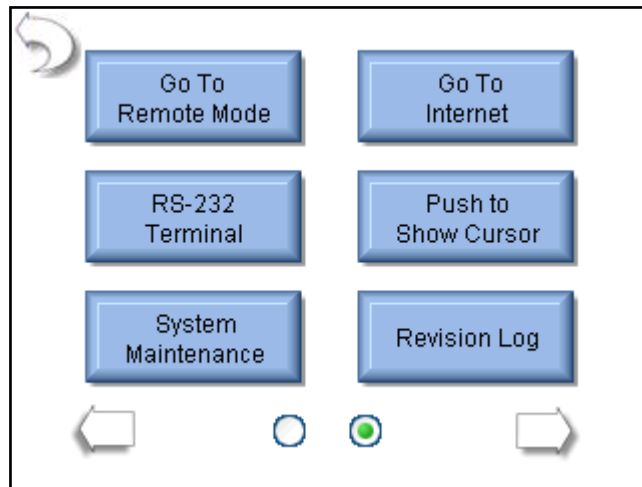

CERHost Configuration – The PC display may flicker or show lines in it based on the ESU-2400 Operating mode. To fix this, go to the Config menu on the CERHost application under Tools | Config and set the update to Whole Screen instead of Line by Line.

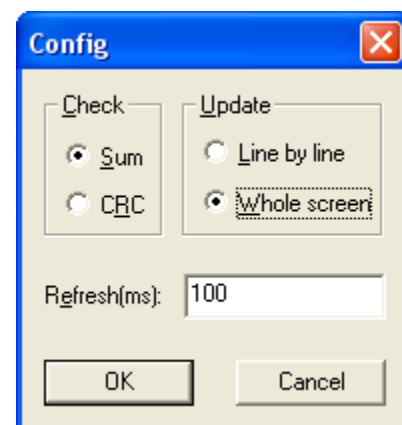
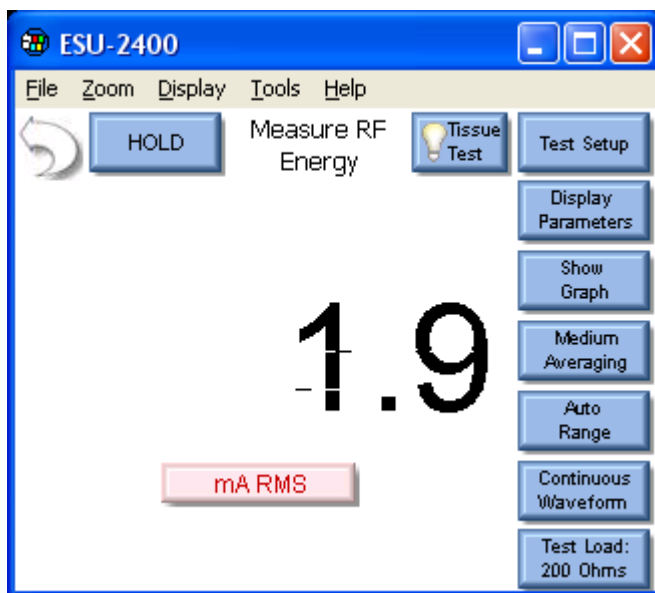

Go To Internet – This button can be used to open internet explorer or to simply validate that the network connection is functioning properly.

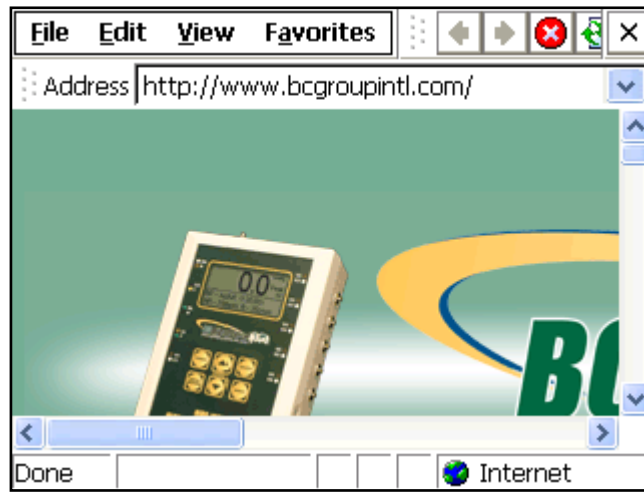

RS-232 Terminal – This button opens the terminal screen, which allows for a direct RS-232 connection to the DUT. A Null modem is required to connect the ESU-2400 to a PC. Some devices require RS-232 commands to enable calibration or service modes. To send data from the ESU-2400 terminal, an external keyboard is required. The terminal can be configured by pressing the Setup button. The ESU-2400 load can be set using the Load button at the bottom of the screen. The current measurement is also shown.

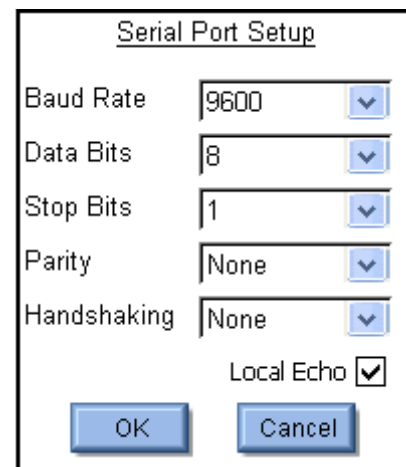
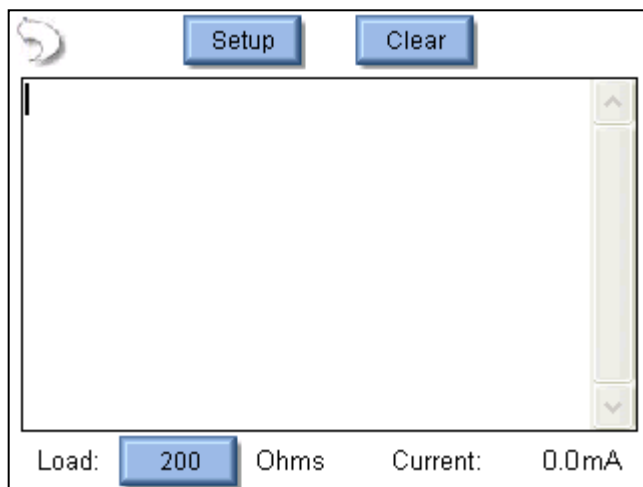

Push To Show (Hide) Cursor – When using a PS/2 type mouse, the cursor will not be displayed automatically. This button is used to toggle the mouse cursor when using a PS/2 type mouse.

System Maintenance – This button is used by the manufacturer to calibrate and debug the ESU-2400.

Revision Log – The revision log contains a list of changes that have been made with each revision of the firmware, software, or OS.

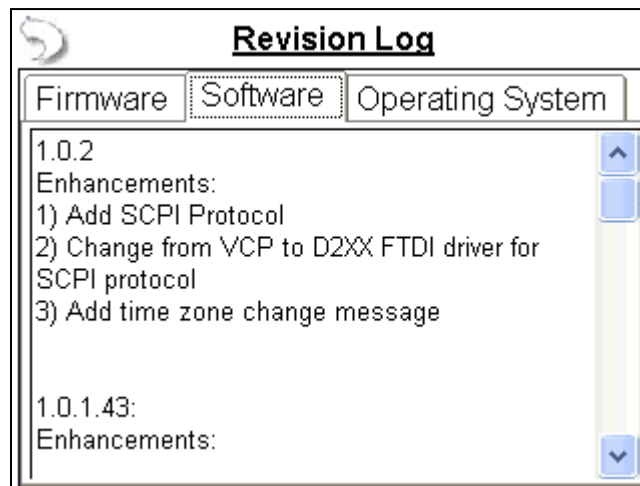

COMMON DIALOG BOXES

Five dialog boxes are used for common user interface functions. The dialog boxes on the ESU-2400 are File Open, File Save, Keypad, Numpad, and Print.

File Open – To open any given file, browse to it in the File List and then either double click on it or click on the file once and then on the OK button. Exit any time by pressing the Cancel button.

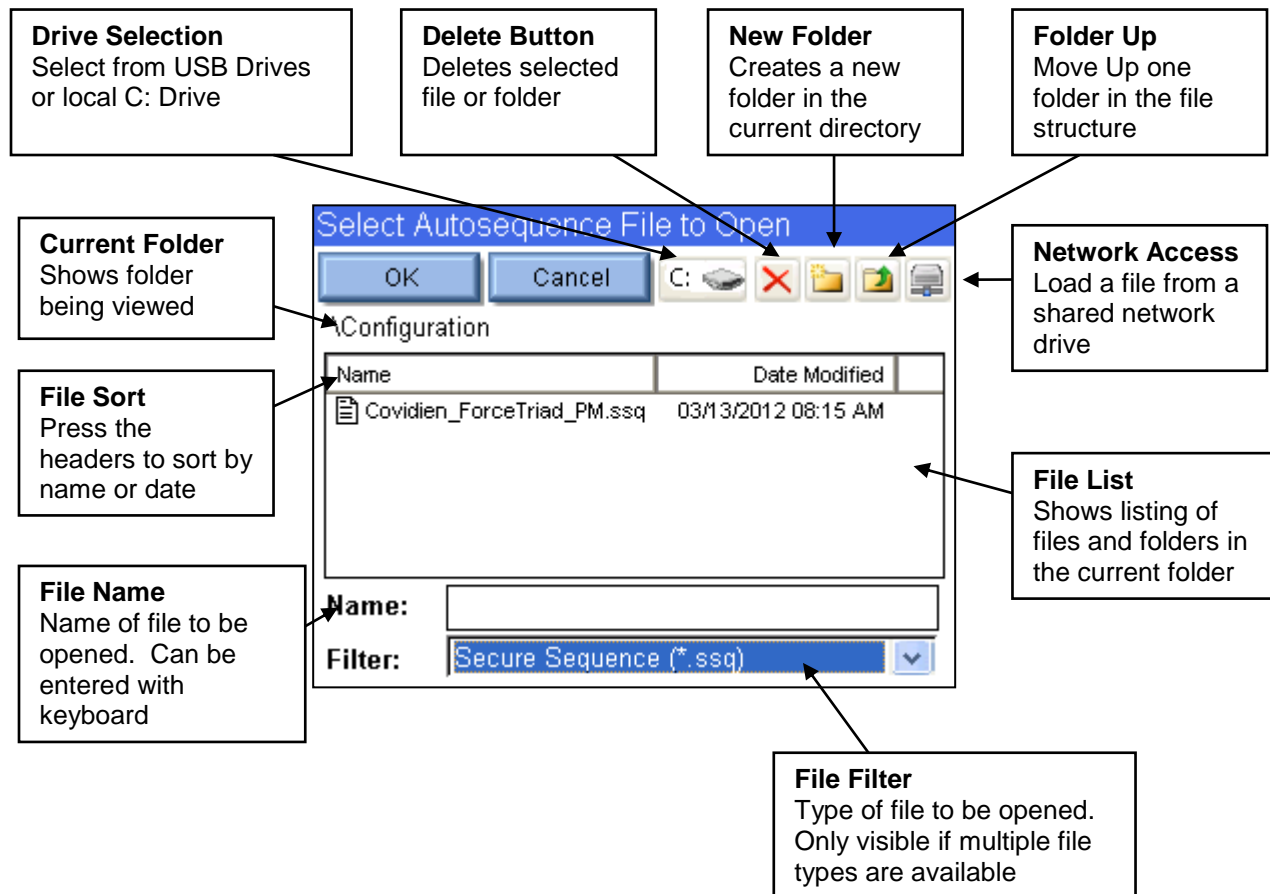

File Save – To save any given file, browse to the desired folder, then press the file name box to open the keypad dialog box. Enter the desired file name and press the OK button. Exit any time by pressing the Cancel button.

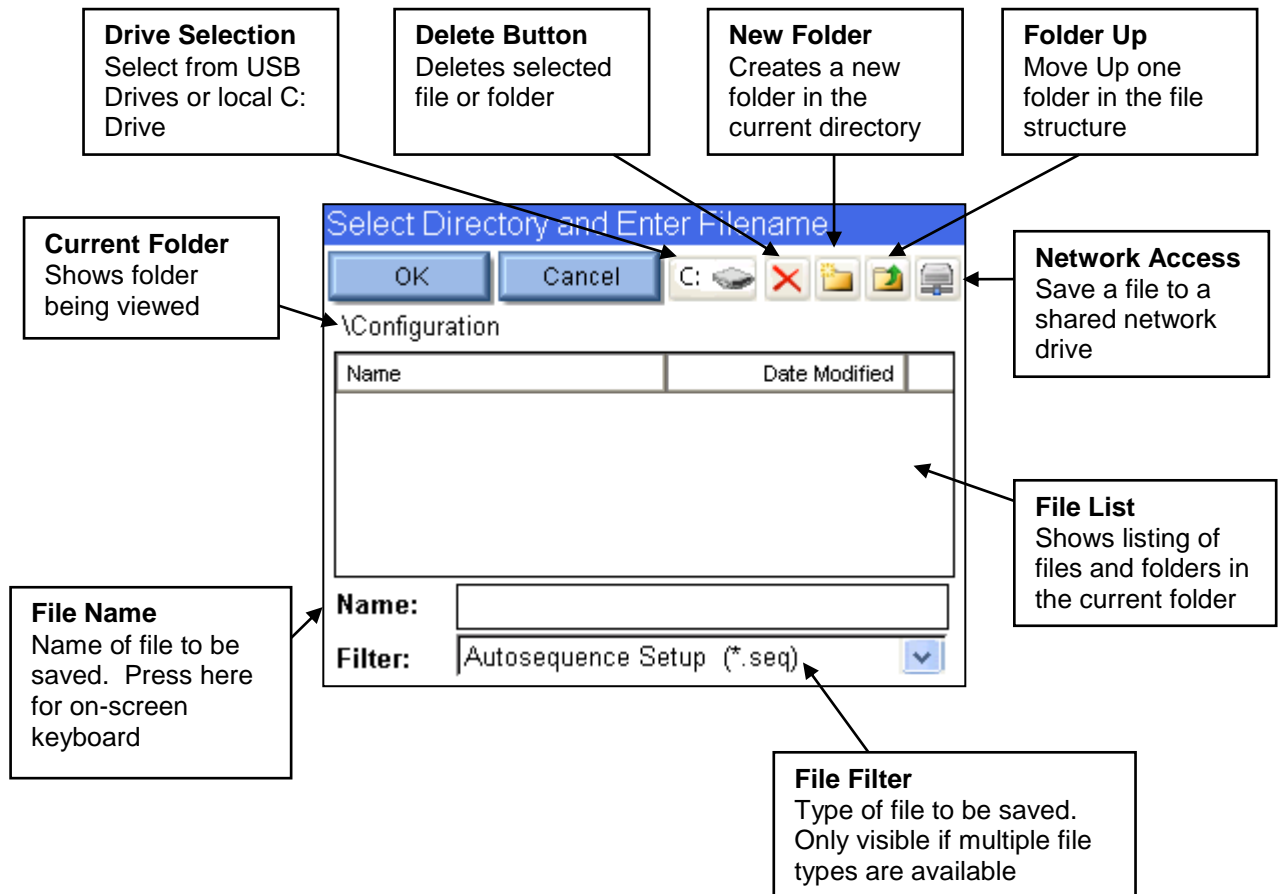

Keypad – This screen allows the user to enter alphanumeric data into the ESU-2400.

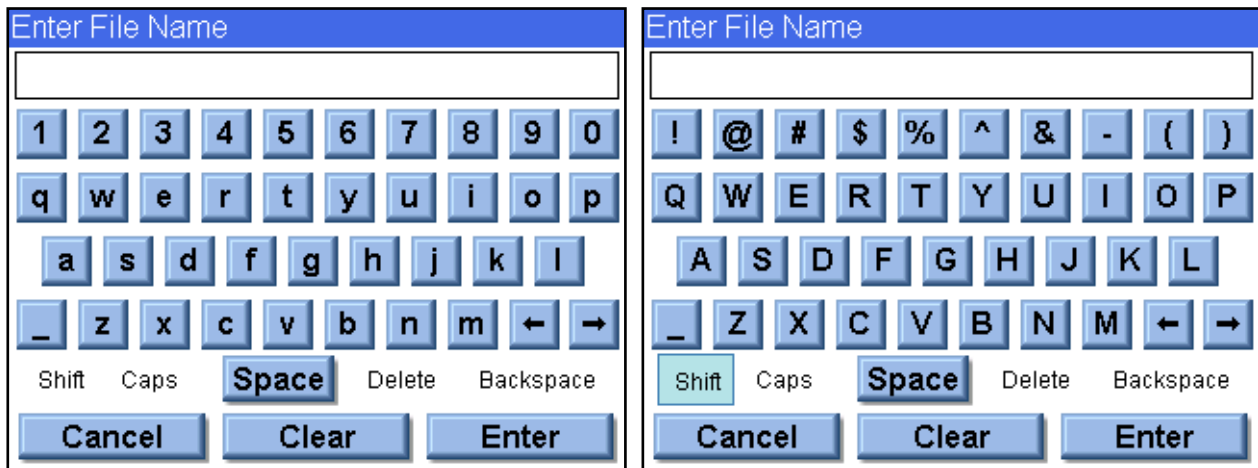

SHIFT – The shift key toggles between upper/lowercase characters and numbers/symbols for a single key entry.

CAPS – The caps key toggles between upper/lowercase characters and numbers/symbols until it is manually disabled.

Cancel – Exits the screen without submitting any values.

Clear – Clears the current text entry box.

Enter – Exits the screen and submits the data in the text entry window.

An external keyboard may also be used to enter data into the keypad entry window. Pressing the Enter key on the keyboard is the same as pressing the Enter key on the screen.

Numpad – This screen is used for numeric data entry.

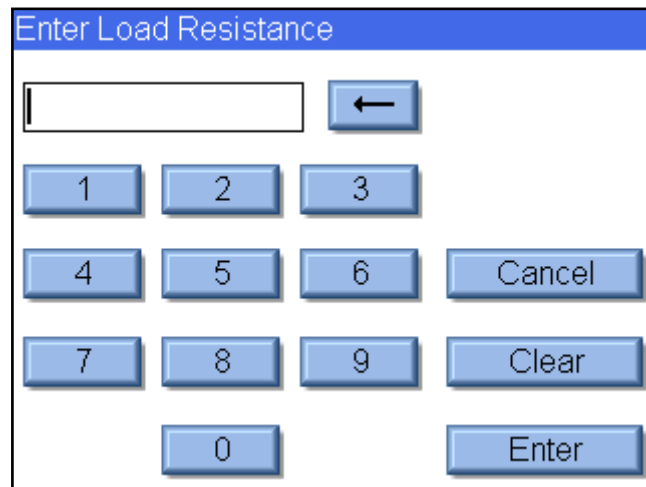

Back Arrow – Deletes a single digit from the entered number.

Cancel – Exits the screen without returning any data.

Clear – Clears the current data entry box.

Enter – Exits the screen and returns the data in the number entry window.

An external keyboard may also be used to enter data into the numpad entry window. Pressing the Enter key on the keyboard is the same as pressing the Enter key on the screen.

Print – The ESU-2400 can print to any printer that supports PCL (printer control language). To date, only HP printers support this method. The ESU-2400 can print to a local printer through USB or to a shared printer on the network.

Local Printing – Local printers are connected to the ESU-2400 through a USB port. The following is an example configuration for local printing.

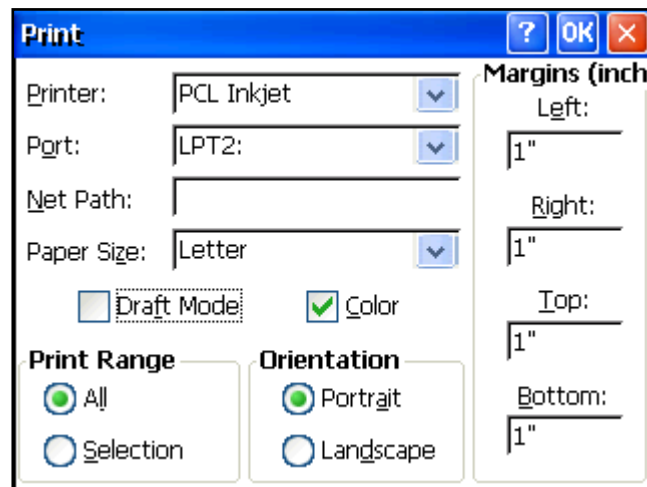

Printer – Select PCL Inkjet or PCL Laserjet based on the type of printer connected to the ESU-2400. Even if the printer name shows up in the list, i.e. OfficeJet H470, select the generic PCL Inkjet or Laserjet instead.

Port – Select LPT2: for local printing. Even though printing is done through the USB port, it is configured as LPT2, regardless of which physical USB port the printer is plugged into.

Net Path – This is unused for local printing and can be ignored.

Paper Size – Set to Letter for proper operation.

Draft Mode – This will print with a reduced quality but slightly faster.

Color – Only available for color printers.

Print Range – Leave setting at “All”.

Orientation – Leave setting at “Portrait”.

Margins – These are currently unused. The ESU-2400 uses margins of 0.5 inches.

Network Printing – Networked printers are connected to a PC on the network. The ESU-2400 must also be connected to the same network. The following is an example configuration for network printing.

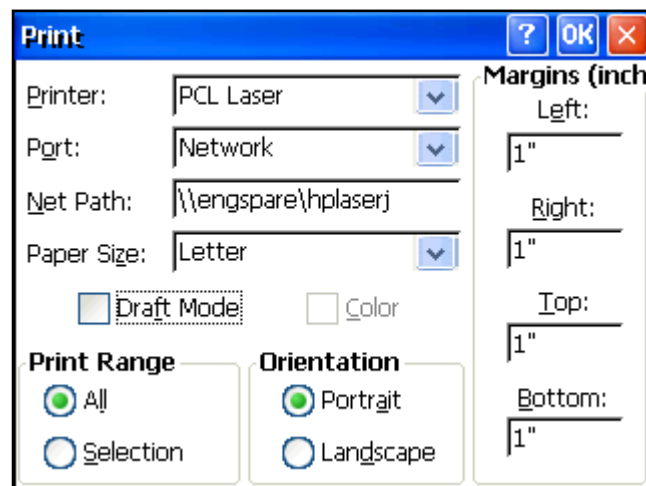

Printer – Select PCL Inkjet or PCL Laserjet based on the type of printer connected to the ESU-2400. Even if the printer name shows up in the list, i.e. OfficeJet H470, select the generic PCL Inkjet or Laserjet instead.

Port – Select Network for network printing.

Net Path – This is the network PC name and printer shared name, formatted as “\\PCname\PrinterShareName”. To get the printer share name, open the printer properties on the PC the printer is connected to and select the Sharing tab.

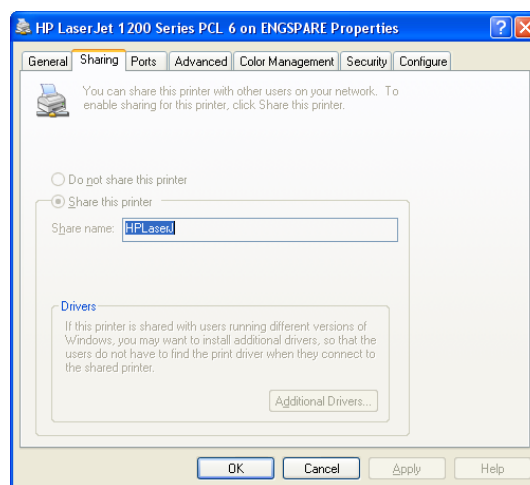

Paper Size – Set to Letter for proper operation.

Draft Mode – This will print with a reduced quality but slightly faster.

Color – Only available for color printers.

Print Range – Leave setting at “All”.

Orientation – Leave setting at “Portrait”.

Margins – These are currently unused. The ESU-2400 uses margins of 0.5 inches.

NOTE: The first time a network printer is used, you may be prompted for a username, password, and domain name.

KEYBOARD AND MOUSE

The ESU-2400 is compatible with standard PS2 or USB keyboards and mice. When a USB mouse is connected to the 2400, the cursor is automatically displayed on the screen. The external keyboard is required when configuring Autosequence Titles and User instructions. The external keyboard is also active any time numerical or text entry is required by the user.

BARCODE SCANNER

The ESU-2400 is compatible with USB type barcode scanners. These scanners can be helpful when entering DUT information. They will act as keyboards that convert barcode data into text. When the ESU-2400 is ready to accept the desired text, simply trigger the barcode scanner instead of typing in the barcode text.

ERROR MESSAGES

The ESU-2400 continuously monitors for various system faults. If a fault occurs, the user will be notified by a warning message as shown below.

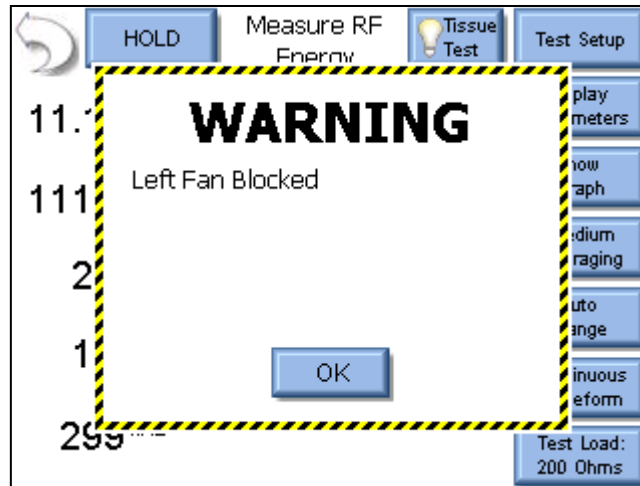

When the user presses the OK button, the warning message is cleared from the screen. After a failure has been detected, the main screen will display an icon indicating that faults are present, as shown below.

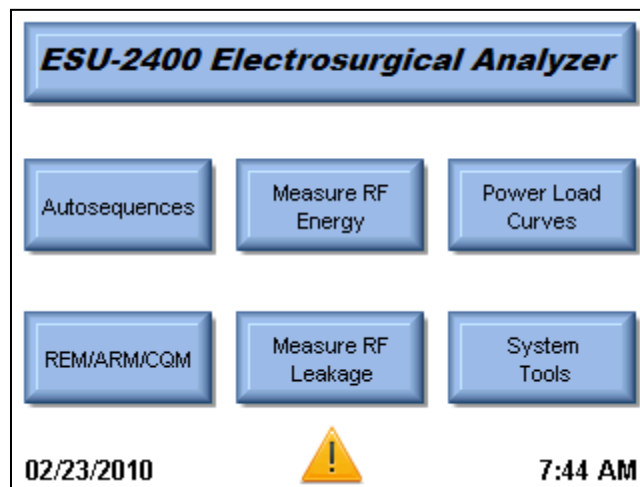

Pressing on the caution icon will display the active faults and the status of the faults. When a fault has been cleared, such as a blocked fan or system overtemp, pressing the Reset Cleared Faults button will remove the fault from the list. Once all faults are cleared, the caution icon will be removed from the main screen.



The following table shows all of the faults that are monitored by the system.

Message	Description	Recovery Action
Left Fan Blocked	The left fan is not spinning. Permanent damage or complete failure could occur.	Check the fan for obstructions. If nothing is found and the fan is not spinning contact BC Biomedical for service.
Right Fan Blocked	The right fan is not spinning. Permanent damage or complete failure could occur.	Check the fan for obstructions. If nothing is found and the fan is not spinning contact BC Biomedical for service.
System Overtemp	The internal temperature has exceeded normal operating conditions.	Stop activating the DUT, allow the system to cool for at least a half hour. If the problem persists, contact BC Biomedical for service.
Footswitch Fuse Open	The internal fuse protecting the power supply to the footswitch interface has opened.	Contact BC Biomedical for service.
Front USB Fuse Open	The internal fuse protecting the power supply to the front USB port has opened.	Contact BC Biomedical for service.
Side USB Fuse (Front) Open	The internal fuse protecting the power supply to the side USB port towards the front of the unit has opened.	Contact BC Biomedical for service.
Side USB Fuse (Rear) Open	The internal fuse protecting the power supply to the side USB port towards the rear of the unit has opened.	Contact BC Biomedical for service.
PS/2 Fuse Open	The internal fuse protecting the power supply to the PS/2 port has opened.	Contact BC Biomedical for service.
No Response from DUT	The ESU-2400 expected RS-232 data from the DUT and did not receive it.	Check the RS-232 cable to ensure that it is seated completely on the ESU-2400 and DUT.
ForceTriad Version Error	The Autosequences are only compatible with ForceTriads running firmware 3.50, or 3.60.	This error will occur if you are trying to use a ForceTriad PM Autosequence on a unit with software version less than 3.50. Go to www.valleylab.com to get a software update for your ForceTriad.

SYSTEM INPUTS AND OUTPUTS

SERIAL COMMUNICATION – There is a serial port on the side panel. The RS-232 Port is used to communicate with the DUT.

USB COMMUNICATION – There are two USB ports on the side panel and one on the front. The USB Ports are used to connect devices such as keyboards, mice, PCL printers, or flash drives.

ETHERNET COMMUNICATION – There is a 10/100 Ethernet port on the side panel. This is used for firmware updates or for connection to a LAN for data storage, remote control, and printing test records.

POWER SWITCH – The main power switch for the Analyzer is located on the front panel. When the switch is ON, the LED should be ON.

LINE POWER – A Kycon 3 position locking receptacle is provided for the 12 VDC Universal Power Supply input. Two receptacles are available, one on the side of the unit and one on the rear. **NOTE: Only one power receptacle should be used at any time.**

The Universal Power Supply takes a Standard Power Adapter Cable with Small Standard Product Plug and Required International Connector (See Options Below).



Pick Your Country's
Connector from Above

to Connect to the
Universal Power Supply

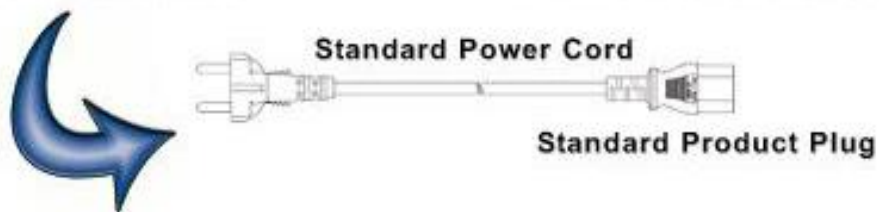

DFA[®] TECHNOLOGY

DFA[®] Digital Fast Acquisition Technology is a revolutionary new method of measuring ESU generator output power. A high-speed analog to digital converter is used to digitize the high frequency, high power output of the ESU generator. An RF Current Transformer is used to convert the current signal to a voltage signal, which is read by the analog to digital converter. By digitizing the signal a more accurate, frequency independent measurement can be made.

FOOTSWITCH OUTPUT CONNECTIONS

The footswitch output enables the ESU-2400 to simulate a footswitch to trigger the DUT. The output is provided on the front panel using a 12 pin locking connector. The mating connector is manufactured by Hirose, part number HR10A-10P-12P(74). The following is the pin configuration for the connector.

Pin	Function	Use
1	Relay 1	Cut
2		
3	Relay 2	Coag
4		
5	Relay 3	Bipolar
6		
7	Relay 4	Future Use
8		
9	Relay 5	Future Use
10		
11	+12V	Future Use
12	GND	

The accessory BC20-03000 is an unterminated footswitch cable. Shown below are the connections for each wire.

Color	Function	Use
Brown	Relay 1	Cut
Red		
Pink	Relay 2	Coag
Yellow		
Green	Relay 3	Bipolar
Blue		
Violet	Relay 4	Future Use
Gray		
White	Relay 5	Future Use
Black		
Red/Blue	+12 VDC	Future Use
Gray/Pink	GND	

COMMUNICATION PROTOCOL

The communication protocol provides a means to completely configure and use the ESU-2400 from a PC. All of the functions available through the front panel can be performed through the communication ports. All of the measurements made by the ESU-2400 are accessible as well. This provides for hands free or automated operation of the ESU-2400.

Communication Ports

The ESU-2400 has three USB ports that can be used to connect to a PC. The connection must be made using an FTDI USB null modem cable (BC Part number BC20-41360). This cable allows the PC to see the connection to the ESU-2400 as a serial port. To determine the serial port number, refer to the Ports section of the Device Manager on the PC. The Serial port is configured as 115,200 Baud Rate, 8 Data Bits, 1 Stop Bit, and No Parity.

Command Syntax

The command description is broken into 3 columns; the KEYWORD, the PARAMETER FORM, and COMMENTS.

Keyword

The KEYWORD column provides the name of the command. The actual name of the command consists of one or more keywords since SCPI commands are based on a hierarchical structure, also known as a **tree system**.

In such a system, associated commands are grouped together under a common node in the hierarchy, analogous to the way leaves at a same level are connected at a common branch. This and similar branches are connected to fewer and thicker branches, until they meet at the root of the tree. The closer to the root, the higher a node is considered in the hierarchy. To activate a particular command, the full path to it must be specified.

This path is represented in the following tables by placing the highest node in the left-most position. Further nodes are indented one position to the right, below the parent node.

The highest level node of a command is called the Keyword, followed by the Node, Subnode, and then the value.

Not all commands require the complexity of the full command path. For example, the Status? command doesn't have a Node or Subnode.

Some commands allow for reading and writing data and some commands are Read Only. To indicate a read function, a question mark (?) is placed at the end of the command path. For example, a write command to change the internal load resistance to 100 ohms would be "CONFigure:RFMeasure:LOAD:INTernal 100<cr>", where <cr> indicates a carriage-return. For example, a mArms read command would be "READ:MArms?<cr>", which would return a value of "xxx.x<cr><lf>" where <cr> is a carriage-return and <lf> is a linefeed.

Lowercase letters indicate the **long-form** of the command (for example, **CONFigure:RFMeasure:INPut:RANGe?**) and can be omitted for simplification. Uppercase letters indicate the abbreviated, or **short-form**, of the commands and must be included (for example, **CONF:RFM:INP:RANG?**).

All commands sent to the unit are terminated with a Carriage Return.

NOTE: Commands can be entered in either upper or lowercase or a mixture of the two, uppercase and lowercase. Commands sent to the ESU-2400 are not case sensitive. Upper and lower cases are only used when documenting the commands.

Parameter Form

The PARAMETER FORM column indicates the number and order of parameters in a command and their legal values. Parameter formats are listed in angle brackets <> while string parameters are simply listed.

Square brackets [] are used to enclose one or more parameters that are optional.

The vertical bar | can be read as "or" and is used to separate alternative parameter options.

The query form of a command is generated by appending a question mark "?" to the last keyword. However, not all commands have a query form, and some commands exist only in the query form. The COMMENTS column is used to indicate this.

Comments

The COMMENTS column indicates any notes.

CONFigure Subsystem

This group allows the user to setup the display and operational settings for the unit. Note that there are independent settings for the Measure RF Energy screen and the Measure RF Leakage screen.

KEYWORD	PARAMETER FORM	COMMENTS
---------	----------------	----------

CONFigure		
:RFMeasure		
:DISPlay	:SxZy nn	S = display_screen_number Z = zone_number

display_screen_number = 1-6
1 = One Parameter
2 = Two Parameters
3 = Three Parameters
4 = Four Parameters
5 = Five Parameters
6 = Display All Parameters

nn = Parameter for selected Zone	
0 = mV RMS	8 = kHz
1 = mA RMS	9 = Time-Pulse On
2 = Watts RMS	10 = Time-Pulse Off
3 = mV Peak	11 = Time-Total Cycle
4 = mV Pk-Pk	12 = % Duty Cycle
5 = mV Pk / mV Pk-Pk	13 = mV Pulse Cycle
6 = mV Pk+	14 = mA Pulse Cycle
7 = Crest Factor	15 = Watts Pulse Cycle

:SCReen < numeric_value >

Range 1-6
1-5 = # display zones
6=Measurement List Display

:AVERaging FAST | SLOW | MEDium

:LOAD :MODE INTernal | EXTernal | INT/EXTernal
:INTernal <numeric_value>
:EXTernal<numeric_value>
:ACTual?

0-6400
0-6400
Read Only, returns calibrated load value, what the 2400 uses for Watts calculations

INPut :RANGe 100 | 1000 | AUTo
:MODE CONTinuous | PULsed
:TYPE ISOLated | GND

CONFigure
 :RFLeakage
 :MODE LKG1A | LKG1B | LKG2 | LKG3

:DISPlay :SxZy nn

S = display_screen_number
 Z = zone_number

display_screen_number = 1-6
1 = One Parameter
2 = Two Parameters
3 = Three Parameters
4 = Four Parameters
5 = Five Parameters
6 = Display All Parameters

nn = Parameter for selected Zone	
0 = mV RMS	8 = kHz
1 = mA RMS	9 = Time-Pulse On
2 = Watts RMS	10 = Time-Pulse Off
3 = mV Peak	11 = Time-Total Cycle
4 = mV Pk-Pk	12 = % Duty Cycle
5 = mV Pk / mV Pk-Pk	13 = mV Pulse Cycle
6 = mV Pk+	14 = mA Pulse Cycle
7 = Crest Factor	15 = Watts Pulse Cycle

:SCReen < numeric_value >

Range 1-6
 1-5 = # display zones
 6=Measurement List Display

:AVERaging FAST | SLOW | MEDium

:LOAD :MODE INTernal | EXTernal | INT/EXTernal
 :INTernal <numeric_value>
 :EXTernal<numeric_value>
 :TOTal?

0-6400
 0-6400
 Read Only, returns combined
 load based on internal

INPut :RANGe 100 | 1000 | AUTo
 :MODE CONTinuous | PULsed

CONFigure		
:CQM		
:LOAD	OPEN or <numeric_value>	Open circuit or 0-500 (ohms)
:COHMs	<numeric_value>	Range 0-500, sets the amount to change the CQM resistance when the ohms UP/Down buttons are used
	:UP	Same as pressing Change by Ohms Up button
	:DOWN	Same as pressing Change by Ohms Down button
	:POHMs <numeric_value>	Range 0-500, sets the amount to change the CQM resistance when the percent UP/Down buttons are used
	:UP	Same as pressing Change by Percent Up button
	:DOWN	Same as pressing Change by Percent Down button
:HOLD	ON OFF	
:MODE	MAIN RFMeasure RFLeakage CQM LCURve ASEquence SYStools	

SYSTEM Subsystem

This group allows the user to setup the startup mode for the unit, as well as directly control the unit, as if pressing the keys on the front panel.

KEYWORD	PARAMETER FORM	COMMENTS
SYSTem		
:VERsion?		Read Only
VOLume		Range 0 – 10
:AVERaging	:FAST <numeric_value>	Range 1-200 (samples)
	:MEDium <numeric_value>	Range 1-200 (samples)
	:SLOW <numeric_value>	Range 1-200 (samples)
	:WINdow <numeric_value>	Range 0.0 to 100.0 (mV)

READ Subsystem

This group allows the user to get measurements from the unit.

KEYWORD	PARAMETER FORM	COMMENTS
READ:	MVrms MArms WArms MVPeak MVPP CF KHZ	Read Only
	TON TOFF TCYC DCYC MVCyc MACyc WCyc	Read Only (pulsed mode)
	ALL?	Returns All readings in comma delimited format
	DATA?	Read only 65535 Bytes hex data, mV values in double byte format Decimal point not included Low Range = 2DP, High=1DP
	TEMP?	Returns system temperature
	SVOLTage?	Returns comma delimited list of system supply voltages: Footswitch Fuse, +12V, Vbacklight, +5V, +3D, +3ETX, +3DISP, VPS2, Front USB, Bottom USB, Top USB

STATus Sub-system

This subsystem provides status on the operating mode of the unit including messages that would normally be seen on the display.

KEYWORD	PARAMETER FORM	COMMENTS																																																			
STATus?	<table border="1"> <thead> <tr> <th>Bit</th> <th>Value</th> <th>Definition</th> </tr> </thead> <tbody> <tr> <td>0</td> <td>1</td> <td>Hold Mode</td> </tr> <tr> <td>1</td> <td>2</td> <td></td> </tr> <tr> <td>2</td> <td>4</td> <td>Calibration Mode</td> </tr> <tr> <td>3</td> <td>8</td> <td></td> </tr> <tr> <td>4</td> <td>16</td> <td>Tissue Response Mode</td> </tr> <tr> <td>5</td> <td>32</td> <td></td> </tr> <tr> <td>6</td> <td>64</td> <td>Tissue Response Test Complete</td> </tr> <tr> <td>7</td> <td>128</td> <td>Tissue Response Test Started</td> </tr> <tr> <td>8</td> <td>256</td> <td>Error Present</td> </tr> <tr> <td>9</td> <td>512</td> <td>mV Out of Range</td> </tr> <tr> <td>10</td> <td>1024</td> <td>mA Out of Range</td> </tr> <tr> <td>11</td> <td>2048</td> <td>Watts Out of Range</td> </tr> <tr> <td>12</td> <td>4096</td> <td>mV Peak Out of Range</td> </tr> <tr> <td>13</td> <td>8192</td> <td>Crest Factor Out of Range</td> </tr> <tr> <td>14</td> <td>16384</td> <td>Fan 1 Blocked</td> </tr> <tr> <td>15</td> <td>32768</td> <td>Fan 2 Blocked</td> </tr> </tbody> </table>	Bit	Value	Definition	0	1	Hold Mode	1	2		2	4	Calibration Mode	3	8		4	16	Tissue Response Mode	5	32		6	64	Tissue Response Test Complete	7	128	Tissue Response Test Started	8	256	Error Present	9	512	mV Out of Range	10	1024	mA Out of Range	11	2048	Watts Out of Range	12	4096	mV Peak Out of Range	13	8192	Crest Factor Out of Range	14	16384	Fan 1 Blocked	15	32768	Fan 2 Blocked	Read Only
Bit	Value	Definition																																																			
0	1	Hold Mode																																																			
1	2																																																				
2	4	Calibration Mode																																																			
3	8																																																				
4	16	Tissue Response Mode																																																			
5	32																																																				
6	64	Tissue Response Test Complete																																																			
7	128	Tissue Response Test Started																																																			
8	256	Error Present																																																			
9	512	mV Out of Range																																																			
10	1024	mA Out of Range																																																			
11	2048	Watts Out of Range																																																			
12	4096	mV Peak Out of Range																																																			
13	8192	Crest Factor Out of Range																																																			
14	16384	Fan 1 Blocked																																																			
15	32768	Fan 2 Blocked																																																			

Common Command Group

This subsystem provides access to common SCPI commands.

KEYWORD	COMMENTS
*IDN?	Read Only, Returns the following information: Manufacturer, Model, Serial Number, Firmware Version, Software Version, OS Version.
*RST	Write Only, Resets unit to default power up state. If selected, the saved profile is loaded, see Profiles on page 98.
*STB?	Read Only, Returns the status byte information:

Bit	Value	Definition
0	1	Hold Mode
1	2	
2	4	Calibration Mode
3	8	
4	16	Tissue Response Mode
5	32	
6	64	Tissue Response Test Complete
7	128	Tissue Response Test Started
8	256	Error Present
9	512	mV Out of Range
10	1024	mA Out of Range
11	2048	Watts Out of Range
12	4096	mV Peak Out of Range
13	8192	Crest Factor Out of Range
14	16384	Fan 1 Blocked
15	32768	Fan 2 Blocked

ESU-2400 Communication Command Summary

From 2400 to PC

Keywords	Nodes	Subnodes	Values	
CONFigure	RFMeasure	DISPlay	SxZy nn x is the Screen # (1-5) and y is the Zone # (1-5). nn=0 to 13: 0=mV RMS 1=mA RMS 2=Watts RMS 3=mV Peak 4=mV Pk-Pk 5=mV Pk / mV Pk-Pk 6=mV Pk+ 7=Crest Factor 8=kHz 9=Time-Pulse On 10=Time-Pulse Off 11=Time-Total Cycle 12=% Duty Cycle 13=mV Total Cycle 14=mA Total Cycle 15=Watts Total Cycle	
			SCReen	Range: 1-6 1-5 = # display zones 6=Measurement List
			AVERaging	FAST, SLOW, MEDium
		LOAD	MODE	INTernal,EXTernal, INT/EXTernal
			INTernal	0-6400 ohms
			EXTernal	0-6400 ohms
			TOTAL?	Returns combined load based on internal / external load mode
		INPut	RANGE	100, 1000, AUTO
			MODE	CONTinuous, PULsed
			TYPE	ISOLated, GND

ESU-2400 Communication Command Summary

From 2400 to PC

Keywords	Nodes	Subnodes	Values	
CONFigure	RFMeasure	DISPlay	SxZy nn x is the Screen # (1-5) and y is the Zone # (1-5). nn=0 to 13: 0=mV RMS 1=mA RMS 2=Watts RMS 3=mV Peak 4=mV Pk-Pk 5=mV Pk / mV Pk-Pk 6=mV Pk+ 7=Crest Factor 8=kHz 9=Time-Pulse On 10=Time-Pulse Off 11=Time-Total Cycle 12=% Duty Cycle 13=mV Total Cycle 14=mA Total Cycle 15=Watts Total Cycle	
			SCReen	Range: 1-6 1-5 = # display zones 6=Measurement List
			AVERaging	FAST, SLOW, MEDium
		LOAD	MODE	INTernal,EXTernal, INT/EXTernal
			INTernal	0-6400 ohms
			EXTernal	0-6400 ohms
			TOTAL?	Returns combined load based on internal / external load mode
		INPut	RANGE	100, 1000, AUTO
			MODE	CONTinuous, PULsed
			TYPE	ISOLated, GND

Communication Command Summary (Continued)

Keywords	Nodes	Subnodes	Values	
CONFigure	CQM	LOAD	OPEN or 0-500 (ohms)	Set or read CQM resistance
		COHMs	0-500 (ohms)	Set or read Change by ohms amount
			UP	Same as pressing change by ohms UP button
			DOWN	Same as pressing change by ohms DOWN button
		POHMs	0-500 (percent)	Set or read Change by Percent amount
			UP	Same as pressing change by Percent UP button
	DOWN		Same as pressing change by Percent DOWN button	
MODE	MAIN, RFMeasure, RFLeakage,CQM,Lcurve,ASEquence, SYStools			
HOLD	ON,OFF (only for RFMeasure, RFLeakage modes)			
SYSTEM	VERsion?	[read only]		
	VOLume	0-10		
	AVERaging	FAST	1-200 (samples)	
		MEDium	1-200 (samples)	
		SLOW	1-200 (samples)	
WINdow		0.0 - 100.0 (mV)		
READ	MVRms?	Returns: mV RMS [read only]		
	MARms?	Returns: mA RMS [read only]		
	WARms?	Returns: Watts RMS [read only]		
	MVPeak?	Returns: mV Peak [read only]		
	MVPP?	Returns: mV Peak to Peak [read only]		
	MVP-PP?	Returns: mV Peak/Peak to Peak [read only]		
	MVPK+?	Returns: mV Positive Peak [read only]		
	CF?	Returns: Crest Factor [read only]		
	KHZ?	Returns: Frequency [read only]		
	TON?	Returns: Time - Pulse On [read only]		
	TOFF?	Returns: Time - Pulse Off [read only]		
	TCYC?	Returns: Time - Total Cycle [read only]		
	DCYC?	Returns: % Duty Cycle [read only]		
	MVCyc?	Returns: mV Total Cycle [read only]		
	MACyc?	Returns: mA Total Cycle [read only]		
	WCyc?	Returns: Watts Total Cycle [read only]		
	ALL?	Returns: All readings in comma delimited format		
	DATA?	Returns: Entire Data Buffer [read only] Length = NUMSamples * 2 Data Format is mV in signed double byte format, Decimal place is assumed based on Input Range (Low Range = 2DP, High Range = 1DP)		
	TEMP?	Returns system temperature (Highest temperature of 8 sensors)		
	SVOLTage?	Returns List of system supply voltages Footswitch Fuse, +12V, Vbacklight, +5V, +3D, +3ETX, +3DISP, VPS2, Front USB, Side USB Bottom, Side USB Top		

Communication Command Summary (Continued)

Keywords	Nodes	Subnodes	Values
STATus?	Bit	Value	Definition
	0	1	Hold Mode
	1	2	
	2	4	Calibration Mode
	3	8	
	4	16	Tissue Response Test Mode
	5	32	
	6	64	Tissue Response Test Completed
	7	128	Tissue Response Test Readings Started
	8	256	Error Present
	9	512	mV Out of Range
	10	1024	mA Out of Range
	11	2048	Watts Out of Range
	12	4096	mV Peak Out of Range
	13	8192	Crest Factor Out of Range
	14	16384	Fan1 Blocked
15	32768	Fan2 Blocked	
*IDN?	Returns Manufacturer, Model, Serial Number, Firmware Version, Software Version, OS Version		
*RST	Resets unit to default power up state. If selected, the saved profile is loaded, see Profiles on page 98.		
*STB?	Returns status byte information, same data format as STATus? command.		

FREQUENTLY ASKED QUESTIONS (FAQ)

Question	Answer
<p>What are the new features in the 1.0.3.16 software?</p>	<p>This latest software release incorporates all previous features of 1.0.3.15, while adding:</p> <ul style="list-style-type: none"> • A “Begin ForceTriad PM” button in the Autosequence menu to quickly begin a PM for a connected ForceTriad • A new secure autosequence to complete a PM on ForceTriads running firmware version 3.60 • A Transfer Files feature in the System Tools menu to quickly copy saved files and folders between the ESU-2400 and an external USB flash drive
<p>What are the new features in the 1.0.3.15 software?</p>	<p>There are many new features, see the User’s manual for details.</p> <ul style="list-style-type: none"> • Added secure autosequence for ForceTriad PM procedure • Option to select details or summary data when saving Autosequence results to PDF files • RS-232 terminal window shows mA measurement and can set load • New secure autosequence, once saved as secure sequence, the settings can’t be modified by user • Copy Step function added to Autosequence configuration • Changed colors to help identify RF Measure and RF Leakage screens • Added ground referenced measurement mode for RF Measure screen • Added network drive access to file open/save • Added sort by filename or date to file open/save
<p>I am trying to take a measurement, why do the readings frequently bounce to zero?</p>	<p>Chances are you are trying to read a pulsed waveform. Try setting the measurement mode to ‘Pulsed’ instead of ‘Continuous’.</p>
<p>How do I measure a bipolar output when there is only a REM and Active cable provided?</p>	<p>Initial units were only shipped with two active leads, Green and Yellow. Use the Yellow active cable to connect from the Active port on the ESU-2400 to one bipolar output on the DUT. Use the Green cable to connect from Dispersive 1 on the ESU-2400 to the other bipolar output on the DUT. Starting with Rev G units, a Blue wire was added to the accessory kit. The Yellow and Blue wires can be used to measure bipolar outputs.</p>
<p>Why aren’t there more pre-programmed autosequences provided with the ESU-2400?</p>	<p>We have been restricted by the ESU manufacturers from including autosequences with the ESU-2400. However, the Quickstart guide can help with configuring autosequences.</p>
<p>I just want to use the ESU-2400 to measure current and don’t need all of the other features. Is there an easy way to do this?</p>	<p>Yes, you can use profiles to configure the ESU-2400 to boot to any screen. Select System Tools from the main screen, then System Setup. The Startup Screen can then be selected and saved to a profile.</p>

Question	Answer
How do I enter text for the Autosequence title or instructions to user?	Click in the text box to be edited. To enter text, you will need an external USB or PS/2 keyboard. You can also enter the text from your PC using the Remote mode.
What is the tissue test, how is it used?	Some generators have the ability to seal tissue and detect when the seal is made. These generators use a changing load impedance to detect the seal. The tissue response test uses a light bulb as a load to simulate changing tissue impedance. This mode will monitor the current and report the value right before the output is turned off.
What is pulsed input mode for? Isn't Coag a pulsed waveform?	Pulsed mode is for measuring outputs that have a relatively long duty cycle such as 20mS off, 500mS on. Typically, the generator will have a special button to enable the pulsed output mode.
The RF Measure screen shows mA, but I need to measure watts. Can the ESU-2400 measure watts?	Yes, press the mA RMS text to select the measurement to be shown. You can also press the Display Parameters button to select how many measurements are shown on the screen at a time.
Why do I have two blue REM cables?	The cable with the center pin is used to enable the dual pad function (REM) on the DUT. This cable is used for REM test mode only. For RF Power measurements the ESU-2400 shorts the two dispersive inputs internally. The blue cable without the pin is used because it disables the REM function on the DUT.
I am testing a ForceTriad. When I key the generator, I get a REM alarm on the ForceTriad.	You must configure the DUT for Demo mode to bypass the REM alarm. Use the Tool icon on the right most display and select Demo Mode from the menu on the left most display.
The ESU-2400 shows a mV RMS measurement. Is this the load voltage?	No, this is the output voltage of the internal Current to Voltage RF transformer. This was included for compatibility with the ESU-2050 analyzer. To get load voltage, multiply the RMS current by the load resistance.

MANUAL REVISIONS

Revision #	Revisions Made
Rev 01	Origination
Rev 02	Miscellaneous Edits
Rev 03	Changed drivers, fixed PS/2 mouse, enhanced User interface, expanded help messages, added footswitch trigger. Revised Analog Specifications.
Rev 04	Added secure Autosequence, ForceTriad PM autosequence, Hyfrecator test mode, updated formatting, misc edits.
Rev 05	Specifications updated, Begin ForceTriad PM button added, Transfer Files feature added

LIMITED WARRANTY

WARRANTY: BC GROUP INTERNATIONAL, INC. WARRANTS ITS NEW PRODUCTS TO BE FREE FROM DEFECTS IN MATERIALS AND WORKMANSHIP UNDER THE SERVICE FOR WHICH THEY ARE INTENDED. THIS WARRANTY IS EFFECTIVE FOR TWELVE MONTHS FROM THE DATE OF SHIPMENT.

EXCLUSIONS: THIS WARRANTY IS **IN LIEU OF** ANY OTHER WARRANTY EXPRESSED OR IMPLIED, INCLUDING, BUT NOT LIMITED TO ANY IMPLIED WARRANTY OF **MERCHANTABILITY** OR FITNESS FOR A PARTICULAR PURPOSE.

BC GROUP INTERNATIONAL, INC. IS NOT LIABLE FOR ANY INCIDENTAL OR CONSEQUENTIAL DAMAGES.

NO PERSON OTHER THAN AN OFFICER IS AUTHORIZED TO GIVE ANY OTHER WARRANTY OR ASSUME ANY LIABILITY.

This Page Intentionally Left Blank

SPECIFICATIONS

RF MEASUREMENT				
INPUT	IMPEDANCE	0-6400 Ω		
	CONNECTION	4mm Safety Jack		
	MAXIMUM VOLTAGE	10kV		
	FREQUENCY	10 kHz – 10 MHz		
	MEASUREMENT METHOD	Pearson current to voltage converter 0.1V : 1A		
VOLTAGE (RMS)	100 mV RANGE	0.20 – 70.00 mV RMS 0.01 mV Resolution		
	1000 mV RANGE	2.0 – 700.0 mV RMS 0.1 mV Resolution		
VOLTAGE (pk, pk-pk)	100 mV RANGE	0.20 – 100.0 mV 0.01 mV Resolution		
	1000 mV RANGE	2.0 – 1000.0 mV 0.1 mV Resolution		
ACCURACY, 100 mV RANGE		$f \leq 1.0$ MHz	1.0 MHz < $f \leq 2.5$ MHz	$f > 2.5$ MHz
	Input ≤ 10.0 mV	$\pm 1\%$ Reading Or ± 0.25 mV	$\pm 1\%$ Reading Or ± 0.25 mV	$\pm 1\%$ Reading Or ± 1.0 mV
	10.0 mV < Input ≤ 35.0 mV	$\pm 1\%$ Reading Or ± 0.25 mV	$\pm (1\%$ Reading + 0.5% Range)	$\pm (6\%$ Reading + 0.5% Range)
	Input > 35.0 mV	$\pm 1\%$ Reading Or ± 0.25 mV	$\pm (1\%$ Reading + 0.5% Range)	$\pm (6\%$ Reading + 5% Range)
ACCURACY, 1000 mV RANGE		$f \leq 2.5$ MHz		$f > 2.5$ MHz
	Input ≤ 50 mV	$\pm 1\%$ Reading Or ± 1 mV		$\pm 1\%$ Reading Or ± 1 mV
	50 mV < Input ≤ 400.0 mV	$\pm 1\%$ Reading		$\pm 4\%$ Reading
	Input > 400.0 mV	$\pm (1\%$ Reading + 0.25% Range)		$\pm (4\%$ Reading + 0.25% Range)

CALCULATED RANGES		
CURRENT	100 mV RANGE	2.0 - 700.0 mA RMS 0.1 mA Resolution
	1000 mV RANGE	20 - 7000 mA RMS 1 mA Resolution
VOLTAGE (mV pk, mV pk-pk)	100 mV RANGE	0.0 - 1.0 mV 0.1 mV Resolution
	1000 mV RANGE	0.0 - 1.0 mV 0.1 mV Resolution
POWER	0 - 999.9 W 0.1 W Resolution	
CREST FACTOR	1.4 – 500 0.1 Resolution	

PULSE MODE TIMING MEASUREMENT	
RESOLUTION	0.1 ms
ACCURACY	± 0.2 ms

LOAD BANK SPECIFICATIONS		
MAXIMUM CURRENT	0 Ω	8 A RMS
	1 – 6400 Ω	3.5 A RMS
INTERNAL LOAD SELECTION	RANGE	0-6400 Ohms
	RESOLUTION	1 Ohm
	ACCURACY	1% ±0.5 Ohm, Non-Inductive
	POWER RATING	1 ohm: 25W 2 ohm: 50W 4 ohm: 100W Remaining loads: 225W
	DUTY CYCLE	10 seconds on, 30 seconds off
	LOAD COOLING	Dual 120mm Variable Speed Fans Controlled by load temperature or input power measurement
EXTERNAL LOAD SELECTION	RANGE	0-6400 Ohms
	RESOLUTION	1 Ohm

EMBEDDED COMPUTER MODULE		
DISPLAY	5.7" QVGA, 320x240 Pixels Color LCD, White LED Backlight	
TOUCHSCREEN	Resistive	
MEMORY	RAM	512Mb DDR2
	DATA STORAGE	2GB, Compact Flash
EXTERNAL PORTS	PS/2 Keyboard / Mouse 10/100 Ethernet 3 USB 1 RS-232	
OPERATING SYSTEM	Windows CE® 6.0 R2	
EXTERNAL DEVICE SUPPORT	Most Windows supported USB flash disks, printers, keyboard/mouse / etc.	

CONNECTIONS	
INPUT CONNECTORS	Color Coded 4mm Safety Banana Connectors
OSCILLOSCOPE OUTPUT	BNC (50 Ω), Uncalibrated
FOOTSWITCH CONNECTOR	Hirose HR10A-10R-12S(71) Mating Connector: Hirose: HR10A-10P-12P(74)
NUMBER OF AVAILABLE FOOTSWITCH CONTROLS	5, relay controlled

PHYSICAL, ENVIRONMENTAL, AND ELECTRICAL	
OPERATING RANGE	15 - 30 °C (59 - 86 °F) 20 - 80% RH, Non-Condensing
STORAGE RANGE	-20 - 60 °C (-4 - 140 °F)
SIZE	7.8 x 15.0 x 22.5 inches 198.1 x 381 x 571.5 mm
WEIGHT	31 lbs (14 kg)
POWER	12 VDC, minimum 4A Kycon 3 position locking receptacle

ESU ANALYZER MODES	
RF MEASUREMENT MODE	Allows use as a general purpose RF meter, including current, voltage, power and timing measurement
LEAKAGE TEST 1A	Tests the open circuit leakage of an Isolated Type CF generator. The test complies with IEC 601.2.2, sec. 19.101b, fig, 104 and sec. 19.102, adopted by ANSI/AAMI HF18-2001
LEAKAGE TEST 1B	Tests the open circuit leakage of an Isolated Type CF generator. The test complies with IEC 601.2.2, sec. 19.101b, fig, 104 and sec. 19.102, adopted by ANSI/AAMI HF18-2001
LEAKAGE TEST 1B	Tests the open circuit leakage of an Isolated Type CF generator. The test complies with IEC 601.2.2, sec. 19.101b, fig, 104 and sec. 19.102, adopted by ANSI/AAMI HF18-2001
LEAKAGE TEST 2	Tests the leakage to ground of Earth-referenced Type BF generators. This test complies with IEC 601.2.2, sec. 19.101a, test 1, fig. 102, and sec. 19.102, adopted by ANSI/AAMI HF18-2001
LEAKAGE TEST 3	Tests the leakage to ground of Earth-Referenced Type BF generators. This test complies with IEC 601.2.2, sec. 19.101a, test 2, fig. 102, and sec. 19.102, adopted by ANSI/AAMI HF18-2001
LOAD CURVE	Allows user to automatically generate a power curve based on varying load, commonly seen in the generator data sheets
REM/ARM/CQM MODE	Uses internal load bank as a variable resistor to test the Generator's CQM/RECQM circuit
AUTOSEQUENCE MODE	Allows user to follow a standard or custom defined protocol to sequentially buildup a test record, applicable to many manufacturer's recommended verification and calibration procedures

NOTES

NOTES

NOTES



**BC GROUP INTERNATIONAL, INC.
3081 ELM POINT INDUSTRIAL DRIVE
ST. CHARLES, MO 63301
USA**

1-800-242-8428

1-314-638-3800

www.bcgrouptl.com
sales@bcgrouptl.com

**ESU-2400 Series User Manual
11/13 – Rev 5**

**Copyright © 2013
Made in the USA**