



HIGH PRECISION / RESOLUTION DIFFERENTIAL DIGITAL PRESSURE METERS



DPM-2350 SERIES

USER MANUAL

**BC BIOMEDICAL
DPM-2350 SERIES
TABLE OF CONTENTS**

WARNINGS, CAUTIONS, NOTICES	2
DESCRIPTION.....	7
OVERVIEW.....	12
KEYS.....	19
OPTIONS	21
COMMUNICATIONS.....	22
MANUAL REVISIONS.....	28
PREVENTIVE MAINTENANCE.....	28
WARRANTY.....	28
SPECIFICATIONS	29
NOTES.....	31

WARNING - USERS

The DPM-2350 Series Meters are for use by skilled technical personnel only.

WARNING - USE

The DPM-2350 Series Meters are intended for testing only and they should never be used in diagnostics, treatment or any other capacity where they would come in contact with a patient.

WARNING - MODIFICATIONS

The DPM-2350 Series Meters are intended for use within the published specifications. Any application beyond these specifications or any unauthorized user modifications may result in hazards or improper operation.

WARNING - CONNECTIONS

All connections to patients must be removed before connecting the Device Under Test (DUT) to the Meter. A serious hazard may occur if the patient is connected when testing with the Meter.

Do not connect any leads from the patient directly to the Meter or DUT.

WARNING - BATTERIES

Turn Power Off and unplug any Battery Eliminator before replacing batteries or cleaning the surface of the Meter.

WARNING - LIQUIDS

Do not submerge or spill liquids on the Meter. Do not operate the Meter if internal components not intended for use with fluids may have been exposed to fluid, as the internal leakage may have caused corrosion and be a potential hazard.

CAUTION - SERVICE

The DPM-2350 Series Meters are intended to be serviced only by authorized service personnel. Troubleshooting and service procedures should only be performed by qualified technical personnel.

CAUTION - ENVIRONMENT

The DPM-2350 Series Meters are intended to function between 15 and 30 °C. Exposure to temperatures outside this range can adversely affect the performance of the Meter.

CAUTION - MEDIA

The DPM-2350 Series Meter is to be used only with a pure fluid or gas that is compatible with Pyrex, Glass, Silicon, Alumina Ceramic, Epoxy, RTV, gold, aluminum and nickel.

CAUTION – PRESSURE LINE

Purge pressure line with distilled water following any application that introduces liquid into the meter.

CAUTION - CLEANING

Do not immerse. The Meter should be cleaned by wiping gently with a damp, lint-free cloth. A mild detergent can be used if desired.

CAUTION - INSPECTION

The DPM-2350 Series Meters should be inspected before each use for wear and the Meter should be serviced if any parts are in question.



NOTICE – CE



The DPM-2350 Series Meters bear the  mark
Based on the following testing standards:

ELECTROMAGNETIC COMPATIBILITY DIRECTIVE

**EMC – Directive 89/336/EEC as amended by 92/31/EEC and 93/68/EEC
& Directive 91/263/EEC[TTE/SES]**

EN 61326-1:1997 + A1:1998 + A2:2001 + A3:2003
“Electrical equipment for measurement, control and
laboratory use – EMC requirements”

This equipment has been type tested by an independent, accredited testing laboratory
and compliance was demonstrated to the above standard to the extent applicable.

EMISSIONS
Radiated Emissions

EN 61326:1997 Annex C

IMMUNITY– CLASS C

EN 61000-4-2:1995
EN 61000-4-3:2006



Electrostatic Discharge
Radiated Electric Field Immunity

LOW VOLTAGE DIRECTIVE **EC – Directive 73/23/EC**

EN 61010-1:2001
“Safety requirements for electrical equipment for measurement, control, and
laboratory use – General requirements”

This equipment has been type tested and compliance was demonstrated
to the above standard to the extent applicable.

NOTICE – SYMBOLS

<u>Symbol</u>	<u>Description</u>
	Caution (Consult Manual for Further Information)
	Center Negative
	Direct Current

NOTICE – ABBREVIATIONS

c	centi- (10^{-2})
C	Celsius
cmH ₂ O	centimeter water
°	degree
DUT	Device Under Test
Euro	European
F	Fahrenheit
FS	Full Scale
hrs	hours
Hz	hertz
inHg	inches mercury
inH ₂ O	inches water
k	kilo- (10^3)
kg/cm ²	kilograms per centimeter squared
kHz	kilohertz
Kpa	kilopascal
μ	micro- (10^{-6})
μA	microampere
m	milli- (10^{-3})
mA	milliampere
mBar	milliBar
mm	millimeter
mmHg	millimeter mercury
Ω	ohm
Press	Pressure
PSI	pounds per square inch
PSIG	pounds per square inch gauge
Sec	seconds
Temp	temperature
US	United States
V	volt
VDC	Direct Current Voltage

NOTICE – DISCLAIMER

USER ASSUMES FULL RESPONSIBILITY FOR UNAUTHORIZED EQUIPMENT MODIFICATIONS OR APPLICATION OF EQUIPMENT OUTSIDE OF THE PUBLISHED INTENDED USE AND SPECIFICATIONS. SUCH MODIFICATIONS OR APPLICATIONS MAY RESULT IN EQUIPMENT DAMAGE OR PERSONAL INJURY.

NOTICE – DISCLAIMER

BC GROUP INTERNATIONAL, INC. RESERVES THE RIGHT TO MAKE CHANGES TO ITS PRODUCTS OR SPECIFICATIONS AT ANY TIME, WITHOUT NOTICE, IN ORDER TO IMPROVE THE DESIGN OR PERFORMANCE AND TO SUPPLY THE BEST POSSIBLE PRODUCT. THE INFORMATION IN THIS MANUAL HAS BEEN CAREFULLY CHECKED AND IS BELIEVED TO BE ACCURATE. HOWEVER, NO RESPONSIBILITY IS ASSUMED FOR INACCURACIES.

NOTICE – CONTACT INFORMATION

BC BIOMEDICAL
BC GROUP INTERNATIONAL, INC.
PO BOX 25125
9415 GENTRY AVE
ST. LOUIS, MO 63125
USA

1-800-242-8428
314-638-3800

www.bcgrouptl.com
sales@bcgrouptl.com

<p style="text-align: center;">BC GROUP DPM-2350 SERIES DIGITAL PRESSURE METERS</p>
--

The Model DPM-2350 Series is a Microprocessor based High Precision High Resolution Digital Pressure Meter family. These meters measure both gas and liquid pressures and provide multiple engineering unit displays for the results.

The DPM-2350 Series meters are intended to be used by skilled technicians in the evaluation and servicing of a wide variety of medical equipment. The following are highlights of some of the main features:

DPM-2351 (Basic Features):

- LARGE GRAPHICS DISPLAY WITH CURSOR SELECTION OF OPTIONS AND SETUP OF PARAMETERS
- 0.05% FS PRESSURE ACCURACY
- STANDARD PRESSURE SCALES INCLUDE 13 DIFFERENT ENGINEERING UNIT RANGES
(PSI, mmHG@0C, mmHg@20C, inHG@0C, inHg@20C, cmH₂O@20C, inH₂O@4C, inH₂O@20C, inH₂O@60F, kg/cm², Kpa, Bar, mBar)
- MAX and MIN PRESSURE VALUE CAPTURE AND STORAGE
- DIGITAL CALIBRATION – NO POTS TO TURN
- SELECTABLE DISPLAY OPTIONS AND DIGIT SIZES
- BATTERY LIFE DISPLAY (0 to 100%)
- PROGRAMMABLE DIGITAL FILTER
- DISPLAY CONTRAST IS SOFTWARE ADJUSTABLE
- 24 BIT MEASUREMENT
- DIGITAL ZERO ADJUSTMENT – NO POTS TO TURN
- DC ANALOG OUTPUT (OPTIONAL)

DPM-2352 ADDS:

- RS232 SERIAL COMMUNICATIONS

TEMPERATURE OPTION ADDS:

- YSI 700 OR 100 Ω RTD TEMPERATURE PROBE INTERFACE
- -20.0 TO 100.0 C / -4.0 TO 212.0 F TEMPERATURE RANGE
- 0.5% FS ACCURACY
- MAX and MIN TEMPERATURE VALUE CAPTURE AND STORAGE

OPTIONAL ACCESSORIES:

BC20 - 21100	BATTERY ELIMINATOR (US Version)
BC20 - 21101	BATTERY ELIMINATOR (Euro Version)
BC20 - 41337	COMMUNICATIONS CABLE (7Pin Mini-Din to DB 9 F)
BC20 - 30106	BC BIOMEDICAL SMALL SOFT SIDED CARRYING CASE
BC20 - 01005	UNIVERSAL PRESSURE ADAPTER KIT
BC20 - 01006	YSI TEMPERATURE CABLE

AVAILABLE MODELS:

There are numerous possible configurations for the DPM-2350. The models can have one pressure sensor with two ports, an optional temperature sensor input and an optional analog output. There are a variety of pressure transducer full-scale values and two types of temperature sensor inputs available. A Min/Max pressure and temperature capture and a hold function are standard. It can be configured with or without an RS232 communications port. The optional DC output provides a DC voltage level output that is proportional to the full scale value of the pressure being measured. The model number configuration guide below calls out these various options and configurations. For additional details on the Pressure and Temperature Sensor Ranges, see next pages.

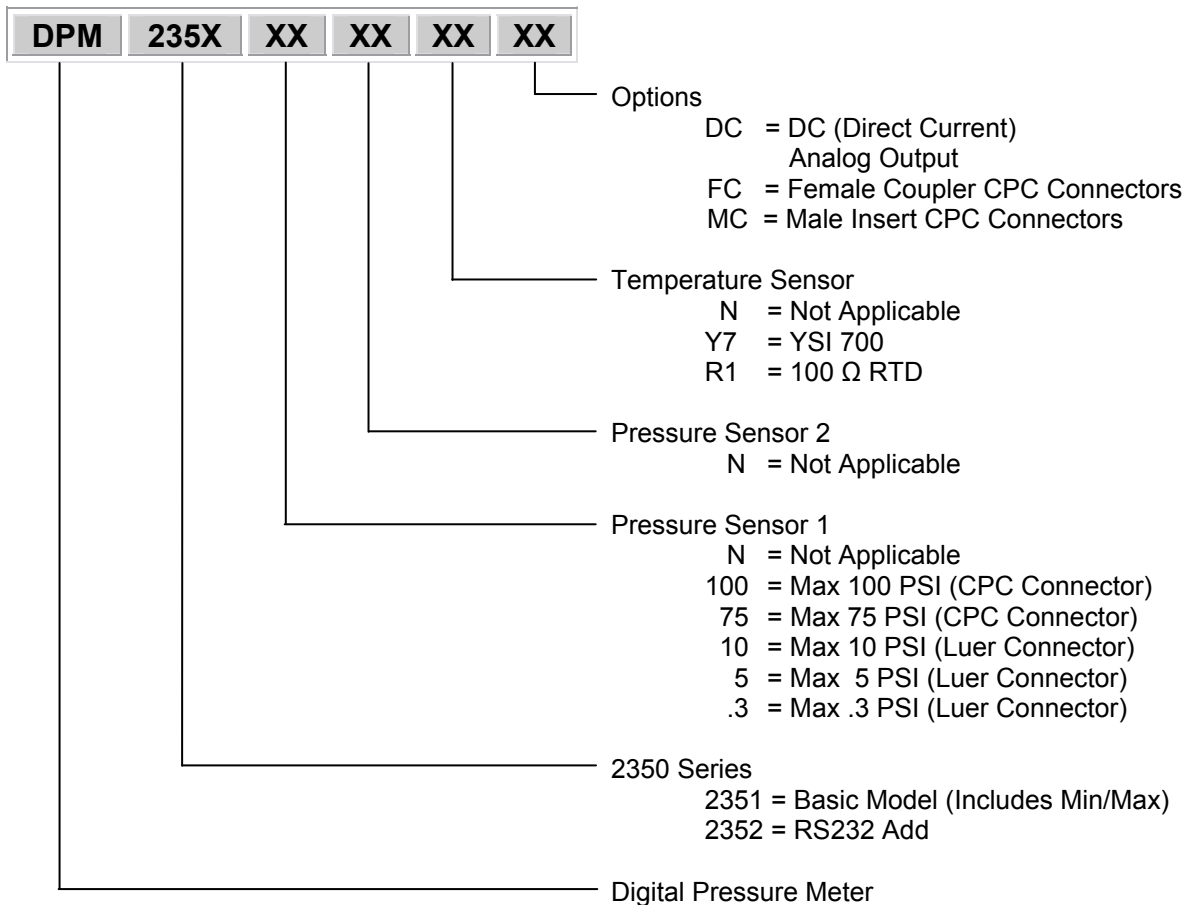

Pressure Sensor 100	
Units	Range
	(Accuracy: .05% FS = +/- 0.05 PSI)
PSI	-13.500 to 100.000
mmHg 0C	-698.2 to 5171.5
mmHg 20C	-700.6 to 5190.3
inHg 0C	-27.486 to 203.602
inHg 20C	-27.586 to 204.342
cmH ₂ O 20C	-951.8 to 7043.2
inH ₂ O 4C	-373.6 to 2768.1
inH ₂ O 20C	-374.3 to 2772.9
inH ₂ O 60F	-374.1 to 2770.8
kg/cm ²	-.9491 to 7.0306
kPa	-93.08 to 689.48
mBar	-930.8 to 6894.8
Bar	-.9308 to 6.8948

Pressure Sensor 75	
Units	Range
	(Accuracy: .05% FS = +/- 0.0375 PSI)
PSI	-13.500 to 75.000
mmHg 0C	-698.2 to 3878.6
mmHg 20C	-700.6 to 3892.7
inHg 0C	-27.486 to 152.702
inHg 20C	-27.586 to 153.256
cmH ₂ O 20C	-951.8 to 5282.4
inH ₂ O 4C	-373.6 to 2076.1
inH ₂ O 20C	-374.3 to 2079.7
inH ₂ O 60F	-374.1 to 2078.1
kg/cm ²	-.9491 to 5.2730
kPa	-93.08 to 517.11
mBar	-930.8 to 5171.1
Bar	-.9308 to 5.1711

Pressure Sensor 10	
Units	Range
	(Accuracy: .05% FS = +/- 0.005 PSI)
PSI	-10.0000 to 10.0000
mmHg 0C	-517.15 to 517.15
mmHg 20C	-519.03 to 519.03
inHg 0C	-20.3602 to 20.3602
inHg 20C	-20.4342 to 20.4342
cmH ₂ O 20C	-704.32 to 704.32
inH ₂ O 4C	-276.81 to 276.81
inH ₂ O 20C	-277.29 to 277.29
inH ₂ O 60F	-277.08 to 277.08
kg/cm ²	-.70307 to .70307
kPa	-68.948 to 68.948
mBar	-689.48 to 689.48
Bar	-.68948 to .68948

Pressure Sensor 5	
Units	Range
	(Accuracy: .05% FS = +/- 0.0025 PSI)
PSI	-5.0000 to 5.0000
mmHg 0C	-258.57 to 258.57
mmHg 20C	-259.51 to 259.51
inHg 0C	-10.1801 to 10.1801
inHg 20C	-10.2171 to 10.2171
cmH ₂ O 20C	-352.16 to 352.16
inH ₂ O 4C	-138.40 to 138.40
inH ₂ O 20C	-138.64 to 138.64
inH ₂ O 60F	-138.54 to 138.54
kg/cm ²	-.35153 to .35153
kPa	-34.473 to 34.473
mBar	-344.74 to 344.74
Bar	-.34474 to .34474

Pressure Sensor .3	
Units	Range
	(Accuracy: .05% FS = +/- 0.00015 PSI, +/- 0.01 cmH2O)
PSI	-.30000 to .30000
mmHg 0C	-15.514 to 15.514
mmHg 20C	-15.571 to 15.571
inHg 0C	-.61081 to .61081
inHg 20C	-.61303 to .61303
cmH ₂ O 20C	-21.129 to 21.129
inH ₂ O 4C	-8.304 to 8.304
inH ₂ O 20C	-8.319 to 8.319
inH ₂ O 60F	-8.312 to 8.312
kg/cm ²	-.021092 to .021092
kPa	-2.0684 to 2.0684
mBar	-20.684 to 20.684
Bar	-.020684 to .020684



Temperature Sensor 100 Ω RTD	
Units	Range
	(Accuracy: .5% FS = +/- 0.5 C)
Degrees C	-20.0 to 100.0
Degrees F	-4.0 to 212.0

Temperature Sensor YSI 700	
Units	Range
	(Accuracy: .5% FS = +/- 0.5 C)
Degrees C	-20.0 to 100.0
Degrees F	-4.0 to 212.0

OVERVIEW

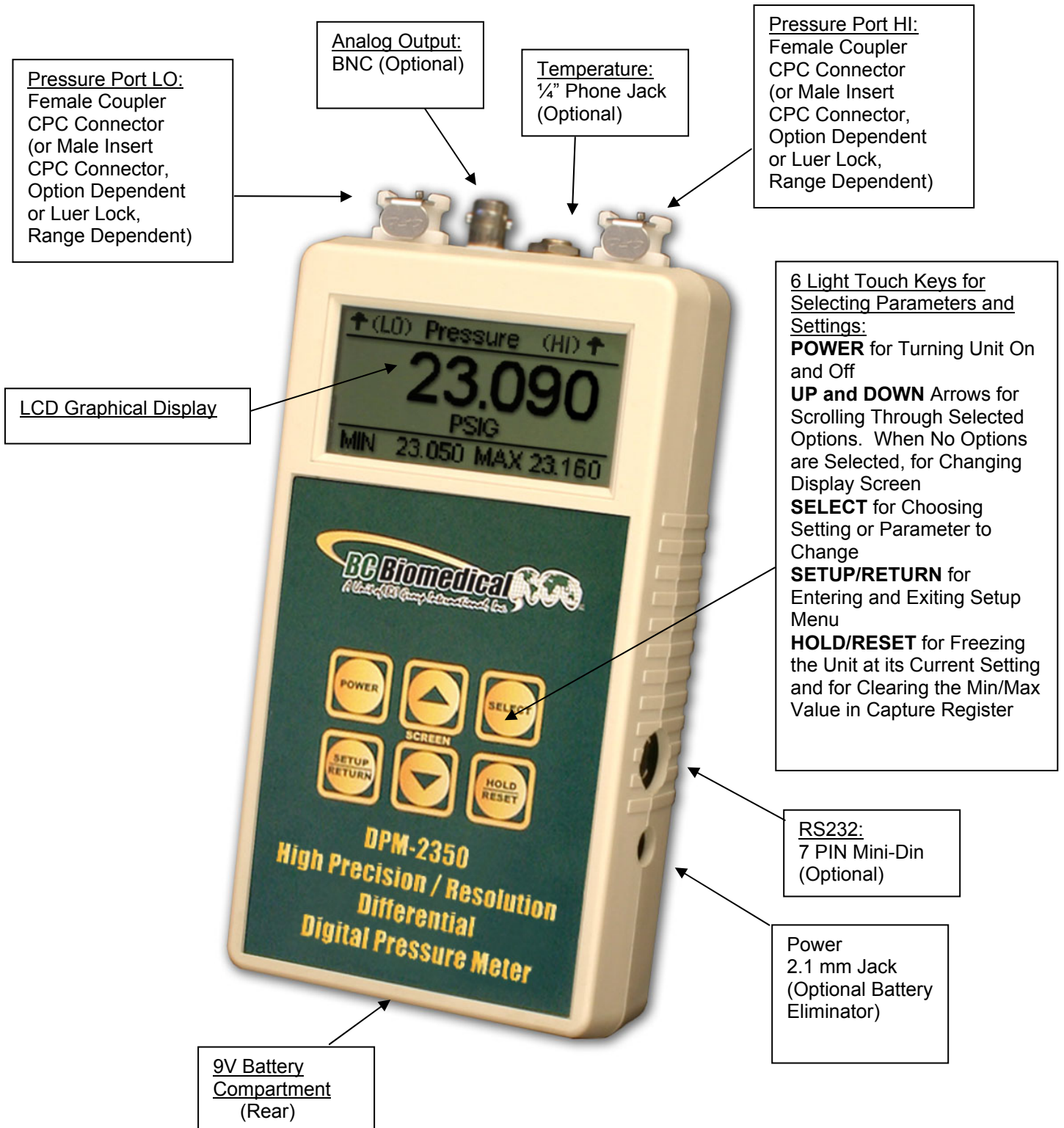
This section looks at the layout of the DPM-2350 and gives descriptions of the elements that are present.



MAIN SCREENS – There can be up to four main screens, depending on the model. They are PRESSURE, TEMPERATURE, COMBINED and INPUTS. The available screens can be toggled through using   .

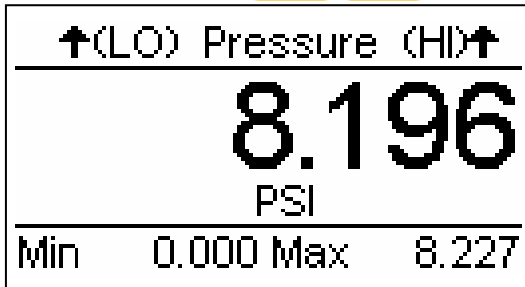

Pressure Display with Min/Max Option selected

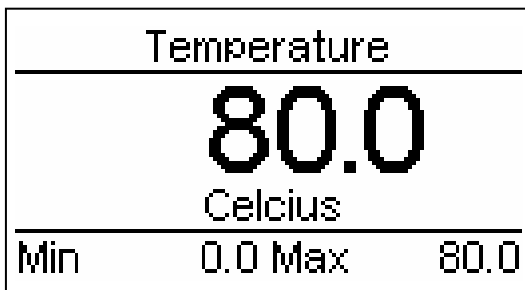

Temperature Display with Min/Max Option selected

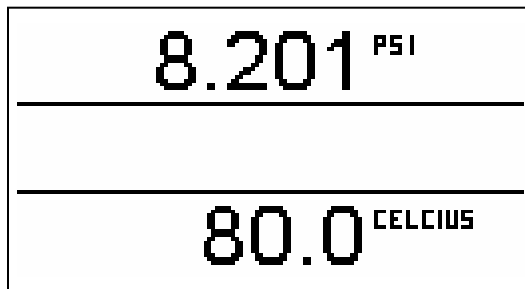

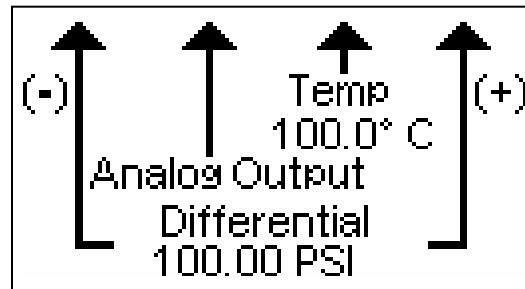

Combined Screen showing:
 Pressure
 Temperature



Input Identification Screen
Note: Sensor limits are displayed based on selected range.

PRESSURE SCALE – The pressure scale is indicated by the units displayed under the reading. The scale can be changed by using  to highlight the unit line and



  to toggle the pressure units.

Pressure Units
PSI
mmHg 0C
mmHg 20C
inHg 0C
inHg 20C
cmH ₂ O 20C
inH ₂ O 4C
inH ₂ O 20C
inH ₂ O 60F
kg/cm ²
kPa
mBar
Bar

NOTE: If the measured pressure is outside of the range of the instrument, an OVER RANGE or UNDER RANGE message box will be displayed.

↑(LO) Pressure (HI)↑	
<div style="border: 1px solid black; padding: 5px; display: inline-block;">Over Range</div>	
PSI	
Min	0.000 Max 100.000

Typical display with “Over Range” message box.





TEMPERATURE SCALE – The temperature scale is indicated by the units displayed under the reading. The scale can be changed by using  to highlight the unit line and   to toggle the temperature units. The following is a breakdown of the available temperature units and the measurement range for typical sensors:

Temperature Sensor
Units
Degrees C
Degrees F

NOTE: If the measured temperature is outside of the range of the instrument, an OVER RANGE or UNDER RANGE message box will be displayed. If a probe is not connected, the NO PROBE message box will be displayed.



Temperature			
<div style="border: 1px solid black; padding: 5px; display: inline-block;">No Probe</div>			
Celcius			
MIN	56.9	MAX	101.6

Typical display with “No Probe” message box.

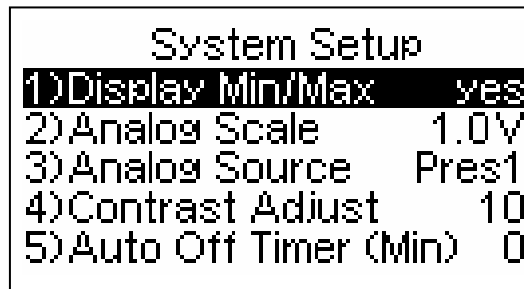
SYSTEM SETUP – The Setup Mode allows the user to adjust the configuration of the meter. The Setup screen can be entered using the  key. The parameters can be changed by using  to highlight the line and  to toggle the available options. The Setup screen can be exited using the  key. The following is a breakdown of the parameters available in the configuration of the unit and their available options:



System Setup Configuration		
Parameter	Description	Range
Display Min/Max	Selects whether the Min and Max values will be displayed on the main screens (except COMBINED).	Yes/No
Analog Scale	Analog Output Scaling voltage. This is the maximum analog output voltage. The output is scaled to this voltage over the positive input of the selected source.	1.0 to 4.0 Volts
Analog Source	Selects the source reading for the analog output	Pres or Temp
Contrast Adjust	Sets the contrast of the display screen.	0-20
Auto Off Timer (Min)	Determines the period of inactivity before the meter is turned OFF. A timer is started when the meter is turned ON and is reset each time a key is pressed. When the timer reaches the value set in this parameter, the power is automatically turned OFF. (NOTE: Setting this parameter to 0 disables the Auto Off timer. When running from line power, the meter does not automatically shut off.)	0-30 Minutes
Battery Life	Displays current life of the battery. At 10%, a warning screen will appear.	0-100% (Read Only)
Beep Length	Sets volume for the audio beep.	0-16
Filter – Pres 1 (Sec)	Determines the number of samples that are averaged in the digital filter. The software has a Digital Filter that averages the readings to produce a stable display.	0-10
Filter – Temp (Sec)	(NOTE: Increasing this setting will cause a more stable display. However, it will also cause a slower response to small changes. The best setting is the smallest number that provides a stable display.)	
Software	Displays current software program.	(Read Only)

ZEROING PRESSURE SCALES – When there are no pressure inputs connected to the unit, the display should read “0.” It may be necessary to zero the pressure scales to remove any errors due to ambient conditions. This is done by depressing the  key until the zeroing instructions are displayed, then depressing   simultaneously to begin the process. The “ZEROING...” message will flash while the scale is being zeroed. When the zeroing instructions are displayed again, the process is complete.

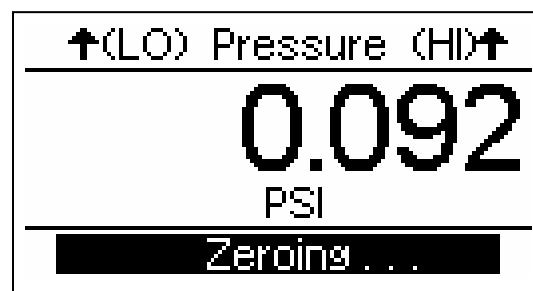
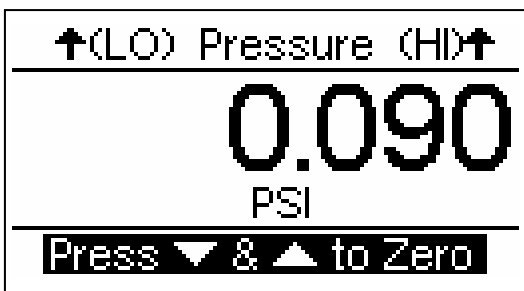

LOW BATTERY – When the battery life reaches 10 percent, the LOW BATTERY message box will be displayed.

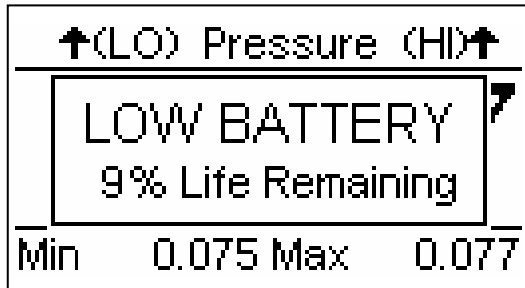

Typical display with “Low Battery” message box.

NOTE: The unit is shipped with a red plug in the Power Input that prevents it from accidentally being turned on, subsequently depleting the battery during transport. This plug must be removed before use.



LINE POWER – A 2.1 mm jack is provided for the optional 9 VDC power supply (BC20 - 21100, BC20 - 21101) that may be used for continuous run applications. It bypasses the internal battery when plugged in.

KEYS

Six tactile-touch keys are provided for system operation:



– This key turns the unit off and on. The unit will return to the main screen that was active when it was turned off.



– In the DISPLAY MODE, these keys toggle the display through the available main screens.

In the SELECT MODE, if a parameter has been highlighted, these keys will scroll through the available settings.





– On any screen, there are a number of parameters that may be selected and changed. This key sequences the cursor (Highlight) through those parameters.



– This key is used to Hold (freeze) and Reset (unfreeze) any of the input displays. Depressing this key will hold the currently displayed Pressure or Temperature reading until reset. Each input can be held independently.

When active, the word “HOLD” is in the display. Depressing this key on a screen that is held will reset that input and remove the word “HOLD” from the display.

NOTE: In the composite screen, the hold feature requires that the specific input be selected using  before  is used.



– This key toggles the unit into and out of the Setup Mode. Depressing this key will enter the Setup screen where the configuration can be viewed and adjusted. Depressing the key again will exit the Setup Mode and return to the previously viewed main screen. This will also save any changes to the internal EEPROM memory so they will be retained even with the power turned off or battery removed.

OPTIONS

ANALOG OUTPUT – The unit may be ordered with a DC (Direct Current) Analog Output. This option provides a filtered Analog Output that matches the displayed pressure or temperature. Filtering is dependent on the Digital Filter Setting (See System Setup section for more information). This is for slowly changing inputs. The output is scaled to match the 0 to Full pressure range of the selected sensor. The scaling voltage can be selected from 1.0 to 4.0 VDC in 0.1V increments.

The source for the analog output is selectable in the Setup Mode. The Analog Source parameter can be selected to track Pressure or Temperature (Temp).

COMMUNICATIONS

Since the meter does not handle any high-bandwidth data links, the RS232 communication port data link has been optimized to allow the user, through very simple instructions, to control and interrogate the meter. The following section describes the JPC Protocol used by the meter.

The Link communicates at a fixed 115,200 baud with 8 bit data, 1 stop bit, 1 start bit, no parity and no handshaking.

The JPC Protocol consists of 6 basic commands:

- R - READ
- W - WRITE
- U - UPLOAD
- Q - QUICKSEND
- V - VERSION
- X - CANCEL

The data format is standard ASCII and all data are BCD values.

The following is a breakdown of each of the commands and the way they are accessed. The meter will echo all characters that are typed to it. When used with a terminal, this will provide the appropriate display. When used with a computer system, this will provide direct feedback of the fact that unit has accepted the data.

All commands are completed with a carriage return from the computer. All commands will be acknowledged by a carriage return, line feed (\$0D,\$0A). If a command is not valid, the meter will respond with "??". All commands are not case sensitive.

READ/WRITE COMMANDS

The READ command is utilized to read from the meter any of the gathered data. The command is entered as a letter followed by 2 numbers, followed by a carriage return:

R(Location)(Return)

The 'R' indicates to the meter that the command is to be a READ command.

The Location contains two digits that indicate the data location that is to be read.

The carriage return indicates that the command is to be activated.

The WRITE command allows the user to update the system settings. The write command is entered as a letter followed by 7 numbers, followed by a carriage return.

W(Location)(Data) (Return)

The 'W' indicates to the meter that the command is to be a WRITE command.

The Location contains two digits that indicate the data location that is to be read.

The Data contains five digits that indicate the data that is to be written at the desired Location.

The carriage return indicates that the command is to be activated.

LOCATION	ACCESS	DESCRIPTION	RANGE
01	R	% BATTERY LIFE REMAINING	0-100
02	R/W	CONTRAST	0-20
03	R/W	AUTO POWER OFF	0-30
04	R	MODEL	
05	R	PRESSURE SENSOR TYPE	0 Not Installed 1 100 PSI Max 2 75 PSI Max 3 10 PSI max 4 5 PSI max 5 0.3 PSI max
06	R/W	PRESSURE UNITS	0 PSI 1 mmHg 0C 2 mmHg 20C 3 inHg 0C 4 inHg 20C 5 cmH ₂ O 20C 6 inH ₂ O 4C 7 inH ₂ O 20C 8 inH ₂ O 60F 9 kg/cm ² 10 kPA 11 mBar 12 Bar
07	R/W	PRESSURE FILTER	0-60
08	R	PRESSURE	See Note 1
09	R/W	PRESSURE MAX	See Note 1, 3
10	R/W	PRESSURE MIN	See Note 1, 3
17	R	TEMPERATURE SENSOR TYPE	0 Not Installed 1 YSI 700 2 RTD 100
18	R/W	TEMPERATURE UNITS	0 = C 1 = F
19	R/W	TEMPERATURE FILTER	0-60
20	R	TEMPERATURE	See Note 2
21	R/W	TEMPERATURE MAX	See Note 2, 3
22	R/W	TEMPERATURE MIN	See Note 2, 3

Note 1 – The units for the pressure data are determined by the setting in Location 6 and 12. This may be set via the Write command or manually using the Range Key. See Description Page for Ranges.

Note 2 – The units for the temperature data are determined by the setting in Location 18. This may be set via the Write command or manually using the Range Key. See Description Page for Ranges.

Note 3 – Writing to Min/Max will reset them to the current value. Any data up to 5 digits will trigger the reset. This is the same function as selecting the Min/Max item in the display and pressing the



The following is an example of how the Read/Write commands are used. For display purposes, the symbol <cR> will be used to identify a carriage return (\$0D), and the symbol <LF> will be used to identify a line feed (\$0A).

Read Command Examples

<u>Data Sent</u>	<u>Data Returned</u>	<u>Meaning</u>
R08<cR>	R08<cR><LF> 10.25 mmHg <cR><LF> *	Echo of Command Sent 10.25 mmHg measured on Pressure Sensor End of Transmission
R11<cR>	R11<cR><LF> 5<cR><LF> *	Echo of Command Sent Pressure Sensor 2 is a 0.3 PSI Max Sensor End of Transmission

Write Command Examples

<u>Data Sent</u>	<u>Data Returned</u>	<u>Meaning</u>
W064 <cR>	W064<cR><LF>	Echo of Command Sent (Set Pressure Sensor units to "inH ₂ O@20C")
W0600004<cR>	W0600004<cR><LF> *	Echo of Command Sent (Set Pressure Sensor units to "inH ₂ O@20C") End of Transmission
W05100<cR>	W05100<cR><LF> ??<cR><LF> *	Echo of Command Sent Invalid Command Response (Location 05 is Read Only) End of Transmission

UPLOAD COMMAND

The Upload command allows the user to read all of the selected device data from locations 1 through 22 with a single command. The data will be transmitted as a single block with each location separated by a carriage return, line feed (\$0D,\$0A).

The following is the format for this command:

U (Return)

See the table in the Read Command section for details on the data structure.

QUICKSEND COMMAND

Quicksend is a feature that allows the user to receive an automatic update of all of the meter data without any user interaction. When the Quicksend feature is turned ON, the meter will automatically send all of the device data every half second. The Quicksend feature is toggled ON and OFF with the Quicksend command.

The following is the format for the 'Q' command:

Q (RETURN)

See the table in the Read Command section for details on the data structure.

VERSION COMMAND

The Version command allows the user to read the Software Version that the unit is running.

To read the Version, the following syntax is used:

V (RETURN)

CANCEL COMMAND

The CANCEL command is simply a way to re-establish proper control, should an error occur or an incorrect command be transmitted. For the most part, an incorrect command will simply be ignored and the meter will prepare for an additional command. However, a command may be cancelled midstream by transmitting an 'X' (ASCII). This command does not require a carriage return, nor will it acknowledge with a carriage return. However, it will echo an 'X' to indicate that the CANCEL command has been received.

The command may also be utilized as a clear and/or acknowledgement of the meter being on line.

MANUAL REVISIONS

<u>Revision #</u>	<u>Program #</u>	<u>Revisions Made</u>
Rev 01	DT7321CA	Origination
Rev 02	DT7321CB	Min/Max made standard, CPC Connector added
Rev 03	DT7321CB	MC and FC option for CPC Connectors added

PREVENTIVE MAINTENANCE

CALIBRATION: Annually

PRESSURE LINE: Purge pressure line with distilled water following any application that introduces liquid into the meter.

BATTERIES: When a "Low Battery" message is displayed, the battery should be replaced immediately or the function of the unit may be impaired. The battery compartment is located on the back of the unit. Use only 9 V Alkaline batteries.

LIMITED WARRANTY

WARRANTY: BC GROUP INTERNATIONAL, INC. WARRANTS ITS NEW PRODUCTS TO BE FREE FROM DEFECTS IN MATERIALS AND WORKMANSHIP UNDER THE SERVICE FOR WHICH THEY ARE INTENDED. THIS WARRANTY IS EFFECTIVE FOR TWELVE MONTHS FROM THE DATE OF SHIPMENT.

EXCLUSIONS: THIS WARRANTY IS **IN LIEU OF** ANY OTHER WARRANTY EXPRESSED OR IMPLIED, INCLUDING, BUT NOT LIMITED TO ANY IMPLIED WARRANTY OF **MERCHANTABILITY** OR FITNESS FOR A PARTICULAR PURPOSE.

BC GROUP INTERNATIONAL, INC. IS NOT LIABLE FOR ANY INCIDENTAL OR CONSEQUENTIAL DAMAGES.

NO PERSON OTHER THAN AN OFFICER IS AUTHORIZED TO GIVE ANY OTHER WARRANTY OR ASSUME ANY LIABILITY.

REMEDIES: THE PURCHASER'S SOLE AND EXCLUSIVE REMEDY SHALL BE: (1) THE REPAIR OR REPLACEMENT OF DEFECTIVE PARTS OR PRODUCTS, WITHOUT CHARGE. (2) AT THE OPTION OF **BC GROUP INTERNATIONAL, INC.**, THE REFUND OF THE PURCHASE PRICE.

SPECIFICATIONS

PRESSURE SENSOR 100	
-RANGE	-13.500 to 100.000 PSI
-RESOLUTION	.001 PSI
-ACCURACY	.05% FS = +/- 0.05 PSI
PRESSURE SENSOR 75	
-RANGE	-13.500 to 75.000 PSI
-RESOLUTION	.001 PSI
-ACCURACY	.05% FS = +/- 0.0375 PSI
PRESSURE SENSOR 10	
-RANGE	-10.0000 to 10.0000 PSI
-RESOLUTION	.0001 PSI
-ACCURACY	.05% FS = +/- 0.005 PSI
PRESSURE SENSOR 5	
-RANGE	-5.0000 to 5.0000 PSI
-RESOLUTION	.0001 PSI
-ACCURACY	.05% FS = +/- 0.0025 PSI
PRESSURE SENSOR .3	
-RANGE	-.30000 to .30000 PSI
-RESOLUTION	.00001 PSI
-ACCURACY	.05% FS = +/- 0.00015 PSI +/- 0.01 cmH ₂ O

TEMPERATURE SENSOR YSI 700	
-RANGE	-20.0 to 100.0° C, -4.0 to 212.0° F
-RESOLUTION	.1°C, .1°F
-ACCURACY	.5% FS = +/- 0.5°C
TEMPERATURE SENSOR 100 RTD	
-RANGE	-20.0 to 100.0° C, -4.0 to 212.0° F
-RESOLUTION	.1°C, .1°F
-ACCURACY	.5% FS = +/- 0.5°C

DISPLAY	LCD Graphical 128 X 64 Pixels
SETUP MEMORY	EEPROM, All Parameters
MEMORY RETENTION	10 Years w/o Power
OPERATING RANGE	15 to 30 Degrees C
STORAGE RANGE	-40 to 60 Degrees C
CONSTRUCTION	Enclosure - ABS Plastic Face - Lexan, Back Printed
SIZE	7.09 x 3.94 x 1.56 inches 180 x 100 x 40 mm (HxWxD)
WEIGHT	≤ 1 lbs. (0.45 kg)
CONNECTIONS	Power - 2.1 mm Center Negative RS232 - 7 pin Mini Din Pressure - .3/5/10 Male Luer 75/100 CPC Coupler or Insert Temperature - 1/4 inch phone Analog Output - BNC
PRESSURE MEDIA	Any pure fluid or gas that is compatible with Pyrex, Glass, Silicon, Alumina Ceramic, Epoxy, RTV, gold, aluminum and nickel.
POWER	LINE: 9VDC, Center Negative BATTERY: 9V Alkaline
POWER CONSUMPTION	ON: less than 18 mA OFF: less than 40 μA
BATTERY LIFE	CONTINUOUS: ~80 hrs. OFF: 12 months
BATTERY ELIMINATOR (OPTIONAL)	BC20 - 21100 -- US BC20 - 21101 -- Euro 9V, 200 mA DC 
ANALOG OUTPUT (OPTIONAL)	1.0 to 4.0 VDC FS, selectable +/- .1% FS DC -- Output dependent on Digital Filter

NOTES

